

Information produit : Bacs en acier Corten



Les bacs en acier corten sont fabriqués en tôle d'épaisseur 2mm. Il est également possible de les fabriquer avec des épaisseurs de 3, 4 ou 5mm.

L'acier Corten est un alliage à base de fer, cuivre, silice, nickel et chrome. Exposé aux intempéries, il s'oxyde en surface et se recouvre d'une pellicule de rouille qui procure à ces bacs un aspect authentique et naturel. Cette pellicule de surface protège le métal en dessous de toute nouvelle corrosion, garantissant au produit une durée de vie particulièrement longue.

Les deux caractéristiques principales de l'acier corten sont un aspect rouillé brun orangé et sa longévité importante.

Avantages :

- Robustesse / durabilité
- Aspect final unique donné par les intempéries
- Aspect chaleureux
- Fabrication sur-mesure possible

En option :

- Pieds de dimensions 100x100x90(H) mm (seulement pour modèles ANDES)
- Application d'une couche d'étanchéité dans le bac possible
- Montage de roulettes possibles (seulement pour modèles ANDES)
- Fixateur Owatrol qui stoppe le phénomène de corrosion



Le chant supérieur des bacs est plié deux fois ce qui procure aux bacs une belle finition et une apparence de robustesse.

En standard, les bacs sont fournis avec des pieds de 15mm de haut et des trous pour le drainage. Il est important que les bacs soient bien drainés et qu'il n'y ait pas d'excès d'eau à l'intérieur.

L'**Hydro Grit** n'est pas recommandé car ce produit retient l'eau.

Modèles disponibles : Andes, Atlas, Celso et Cado.



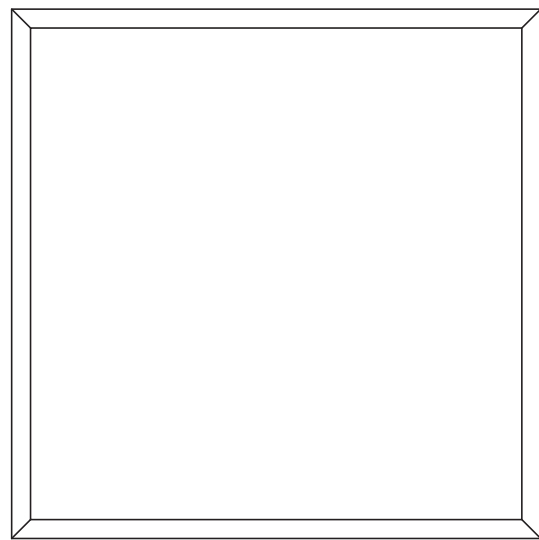

50
1300
1400
50

50 1300 50
1400

Bovenaanzicht

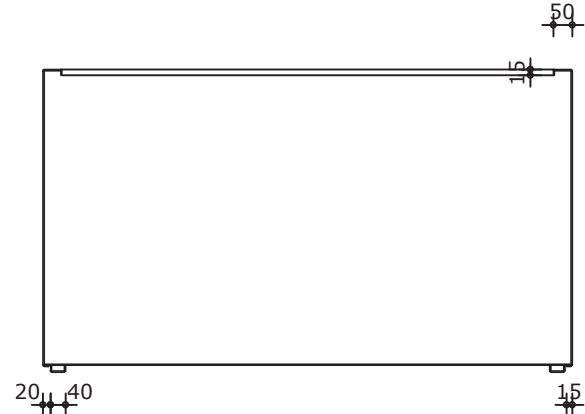

Verticale doorsnede

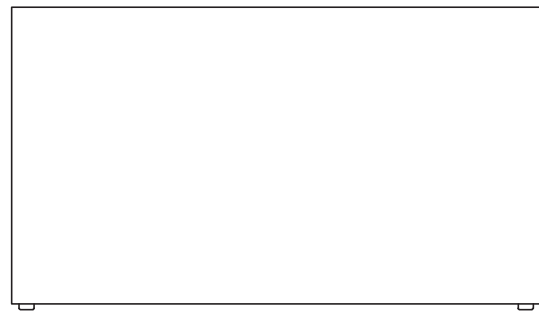

785
800
15

Vooraanzicht

Inhoud : 1.57m3
Gewicht : 112kg
Afwerking : Nvt

| | |
|--------------------------|--------------------|
| Omschrijving : Andes CA1 | Get. : R. Langens |
| Opdrachtgever : Adezz | Schaal : 1:20 |
| Werknummer : Standaard | Datum : 01-04-2014 |
| Plaats : Uden (NL) | Wijz. : |
| Blad : 1/1 | |



Mandenmakerstraat 9, 5405 BJ Uden.
Postbus 607, 5400 AP Uden (NL).
t 0031 (0)413 - 24 6059.
e info@adezz.com, i www.adezz.com

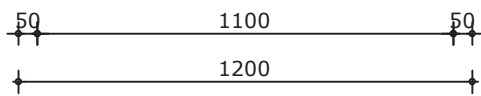
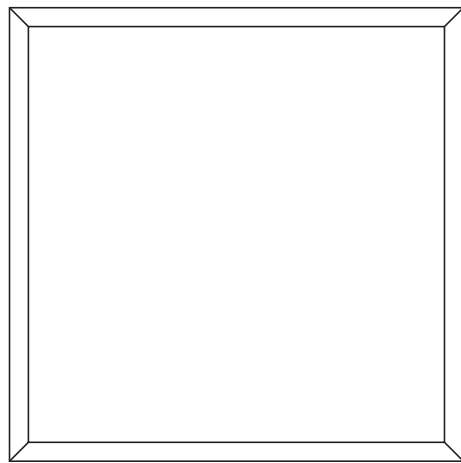

Bovenaanzicht

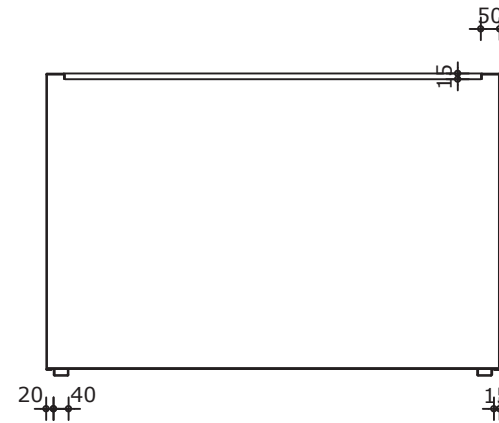

Verticale doorsnede

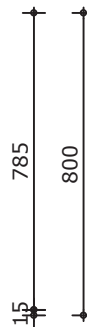
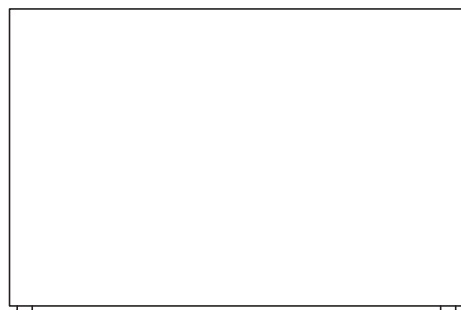

Voorbeeld

Inhoud : 1.15m3
Gewicht : 93kg
Afwerking : Nvt

Omschrijving : Andes CA2
Opdrachtgever : Adezz
Werknnummer : Standaard
Plaats : Uden (NL)
Blad : 1/1

Get. : R. Langens
Schaal : 1:20
Datum : 01-04-2014
Wijz. :



Mandenmakerstraat 9, 5405 BJ Uden.
Postbus 607, 5400 AP Uden (NL).
t 0031 (0)413 - 24 6059.
e info@adezz.com, i www.adezz.com

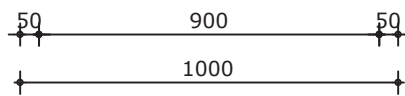
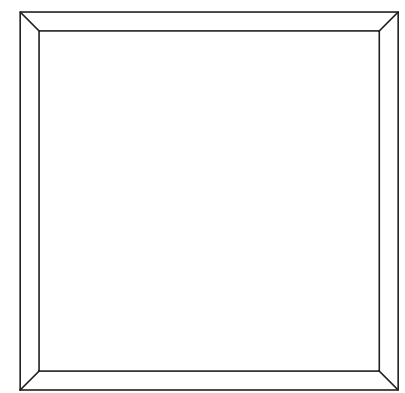

Bovenaanzicht

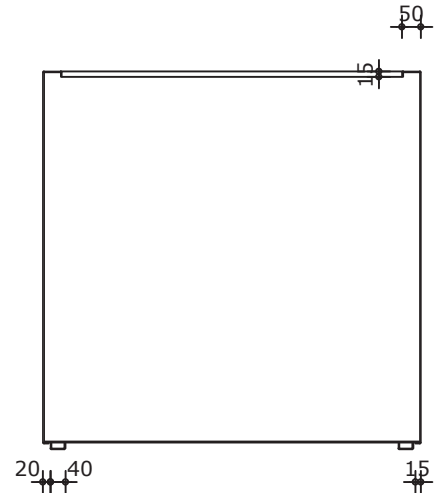

Verticale doorsnede

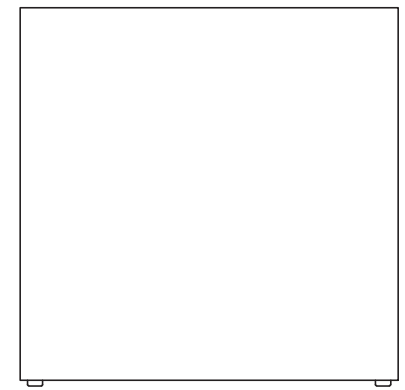

Vooraanzicht



Inhoud : 1.00m3
Gewicht : 89kg
Afwerking : Nvt

| | |
|---|---|
| Omschrijving : Andes CA3 Opdrachtgever : Adezz Werknummer : Standaard Plaats : Uden (NL) Blad : 1/1 | Get. : R. Langens Schaal : 1:20 Datum : 01-04-2014 Wijz. : |
|---|---|



Mandenmakerstraat 9, 5405 BJ Uden.
Postbus 607, 5400 AP Uden (NL).
t 0031 (0)413 - 24 6059.
e info@adezz.com, i www.adezz.com

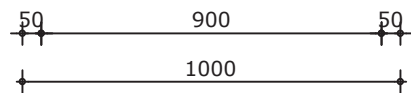
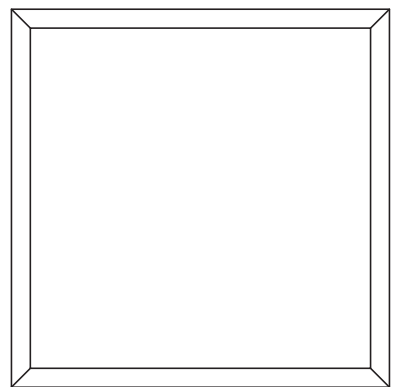

Bovenaanzicht

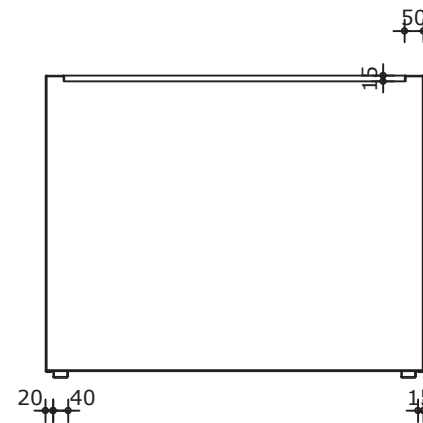
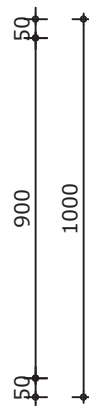

Verticale doorsnede

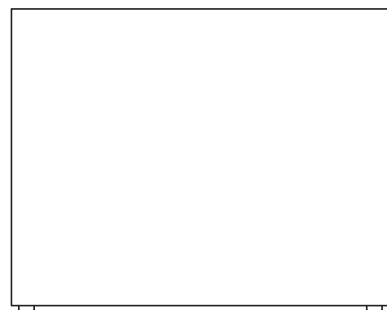

Vooraanzicht

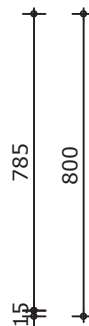

Inhoud : 0.80m3
Gewicht : 75kg
Afwerking : Nvt

Omschrijving : Andes CA4
Opdrachtgever : Adezz
Werknnummer : Standaard
Plaats : Uden (NL)
Blad : 1/1

Get. : R. Langens
Schaal : 1:20
Datum : 01-04-2014
Wijz. :



Mandenmakerstraat 9, 5405 BJ Uden.
Postbus 607, 5400 AP Uden (NL).
t 0031 (0)413 - 24 6059.
e info@adezz.com, i www.adezz.com

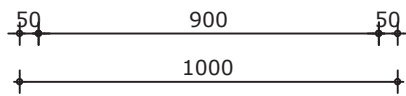
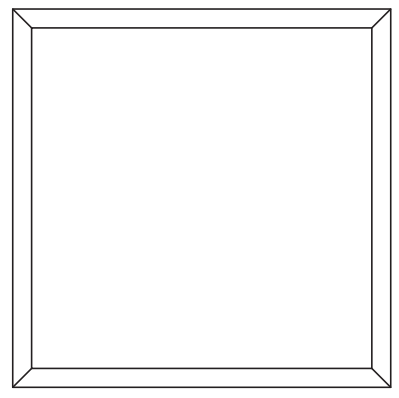

Bovenaanzicht

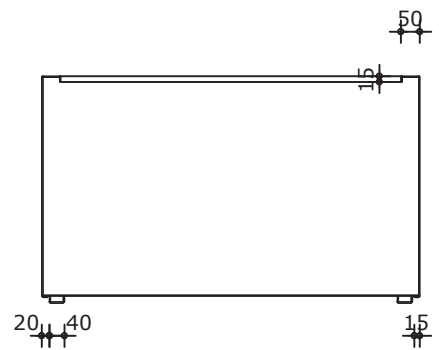

Verticale doorsnede

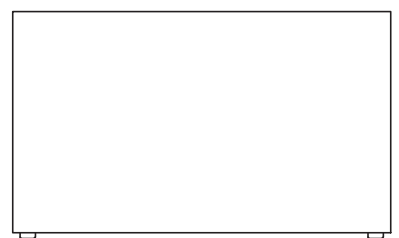

Vooraanzicht



Inhoud : 0.60m3
 Gewicht : 60kg
 Afwerking : Nvt

| | |
|---|---|
| Omschrijving : Andes CA4.1 Opdrachtgever : Adezz Werknummer : Standaard Plaats : Uden (NL) Blad : 1/1 | Get. : R. Langens Schaal : 1:20 Datum : 01-04-2014 Wijz. : |
|---|---|



Mandenmakerstraat 9, 5405 BJ Uden.
 Postbus 607, 5400 AP Uden (NL).
 t 0031 (0)413 - 24 6059.
 e info@adezz.com, i www.adezz.com

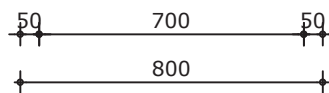
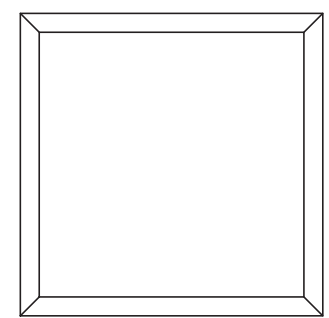

Bovenaanzicht

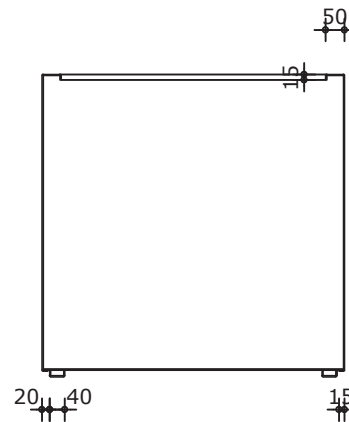
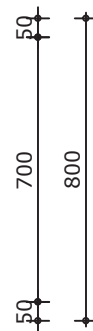

Verticale doorsnede

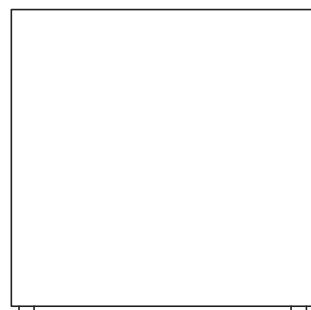

Vooraanzicht

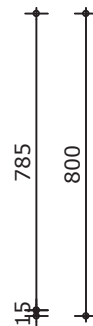

Inhoud : 0.51m3
Gewicht : 54kg
Afwerking : Nvt

Omschrijving : Andes CA5
Opdrachtgever : Adezz
Werknummer : Standaard
Plaats : Uden (NL)
Blad : 1/1

Get. : R. Langens
Schaal : 1:20
Datum : 01-04-2014
Wijz. :



Mandenmakerstraat 9, 5405 BJ Uden.
Postbus 607, 5400 AP Uden (NL).
t 0031 (0)413 - 24 6059.
e info@adezz.com, i www.adezz.com

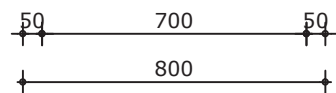
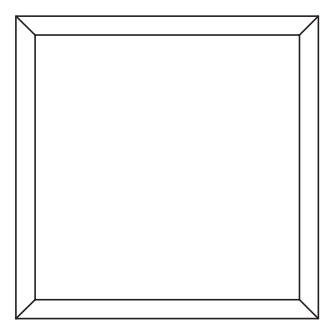

Bovenaanzicht

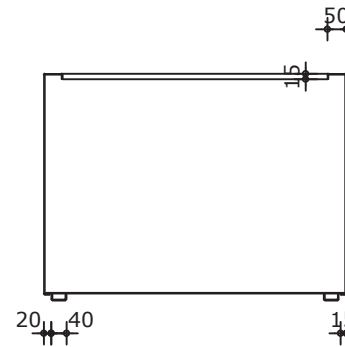

Verticale doorsnede

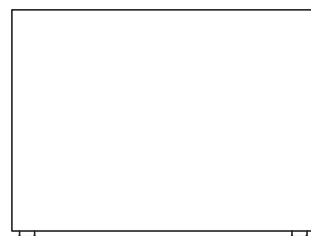

Vooraanzicht

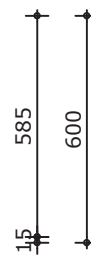

Inhoud : 0.38m3
Gewicht : 44kg
Afwerking : Nvt

Omschrijving : Andes CA5.1
Opdrachtgever : Adezz
Werknnummer : Standaard
Plaats : Uden (NL)
Blad : 1/1

Get. : R. Langens
Schaal : 1:20
Datum : 01-04-2014
Wijz. :



Mandenmakerstraat 9, 5405 BJ Uden.
Postbus 607, 5400 AP Uden (NL).
t 0031 (0)413 - 24 6059.
e info@adezz.com, i www.adezz.com

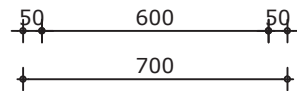
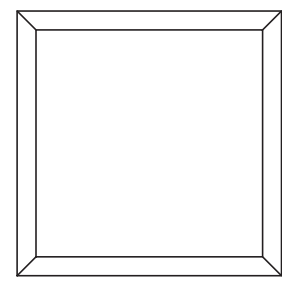

Bovenaanzicht

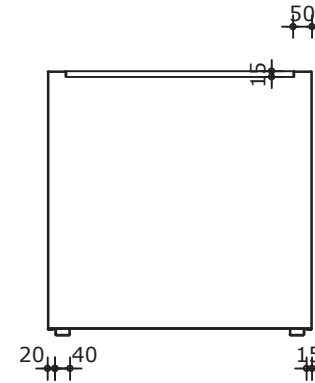

Verticale doorsnede

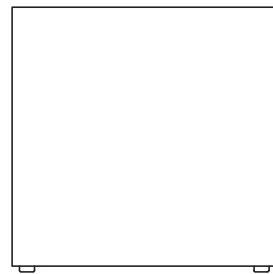

Vooraanzicht



Inhoud : 0.34m3
Gewicht : 42kg
Afwerking : Nvt

Omschrijving : Andes CA6
Opdrachtgever : Adezz
Werknummer : Standaard
Plaats : Uden (NL)
Blad : 1/1

Get. : R. Langens
Schaal : 1:20
Datum : 01-04-2014
Wijz. :



Mandenmakerstraat 9, 5405 BJ Uden.
Postbus 607, 5400 AP Uden (NL).
t 0031 (0)413 - 24 6059.
e info@adezz.com, i www.adezz.com

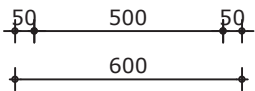
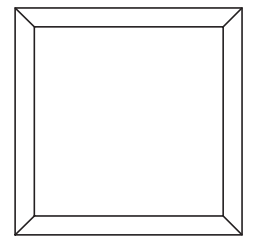

Bovenaanzicht

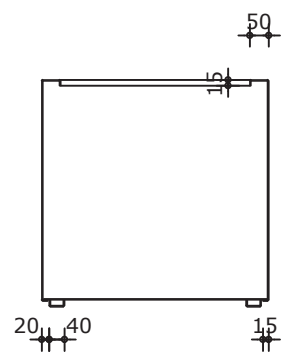

Verticale doorsnede

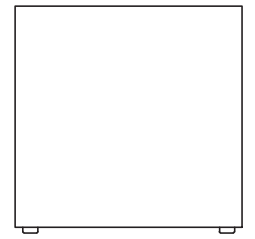

Vooraanzicht

Inhoud : 0.22m3
Gewicht : 31 kg
Afwerking : Nvt

| | |
|---|---|
| Omschrijving : Andes CA7 Opdrachtgever : Adezz Werknummer : Standaard Plaats : Uden (NL) Blad : 1/1 | Get. : R. Langens Schaal : 1:20 Datum : 01-04-2014 Wijz. : |
|---|---|



Mandenmakerstraat 9, 5405 BJ Uden.
Postbus 607, 5400 AP Uden (NL).
t 0031 (0)413 - 24 6059.
e info@adezz.com, i www.adezz.com

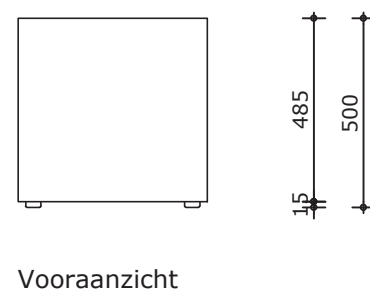
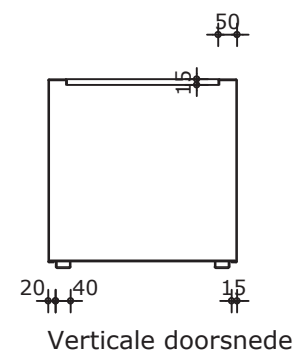
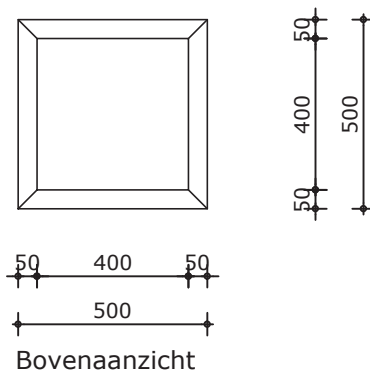

Inhoud : 0.13m3
 Gewicht : 22kg
 Afwerking : Nvt

| | |
|--------------------------|--------------------|
| Omschrijving : Andes CA8 | Get. : R. Langens |
| Opdrachtgever : Adezz | Schaal : 1:20 |
| Werknummer : Standaard | Datum : 01-04-2014 |
| Plaats : Uden (NL) | Wijz. : |
| Blad : 1/1 | |



Mandenmakerstraat 9, 5405 BJ Uden.
 Postbus 607, 5400 AP Uden (NL).
 t 0031 (0)413 - 24 6059.
 e info@adezz.com, i www.adezz.com

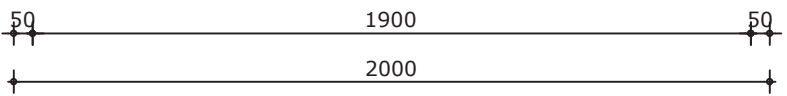
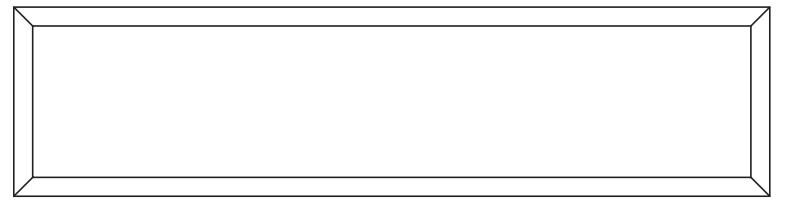

Bovenaanzicht

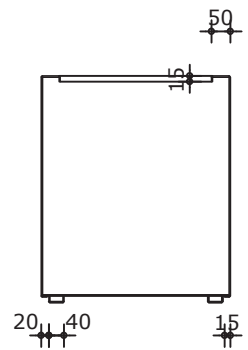

Verticale doorsnede

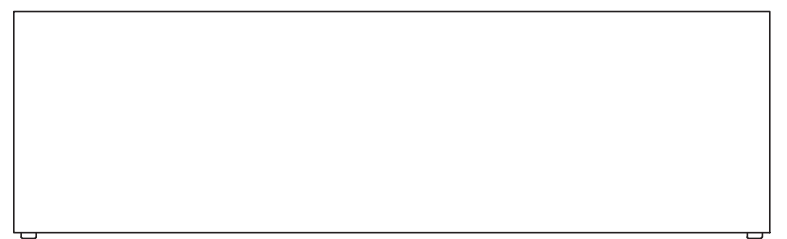

Vooraanzicht

Inhoud : 0.60m3
Gewicht : 69kg
Afwerking : Nvt

| | |
|--------------------------|--------------------|
| Omschrijving : Andes CA9 | Get. : R. Langens |
| Opdrachtgever : Adezz | Schaal : 1:20 |
| Werknummer : Standaard | Datum : 01-04-2014 |
| Plaats : Uden (NL) | Wijz. : |
| Blad : 1/1 | |



Mandenmakerstraat 9, 5405 BJ Uden.
Postbus 607, 5400 AP Uden (NL).
t 0031 (0)413 - 24 6059.
e info@adezz.com, i www.adezz.com

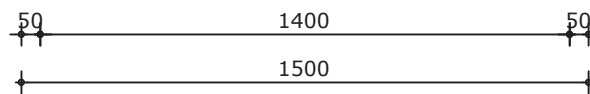
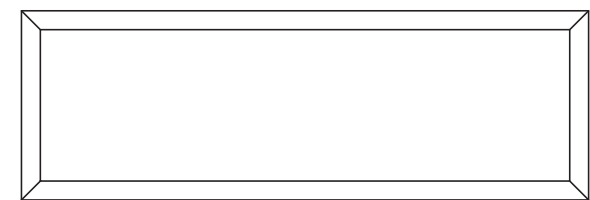

Bovenaanzicht

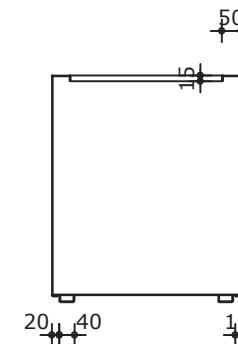

Verticale doorsnede



Vooraanzicht

Inhoud : 0.45m3
Gewicht : 54kg
Afwerking : Nvt

Omschrijving : Andes CA10
Opdrachtgever : Adezz
Werknummer : Standaard
Plaats : Uden (NL)
Blad : 1/1

Get. : R. Langens
Schaal : 1:20
Datum : 01-04-2014
Wijz. :



Mandenmakerstraat 9, 5405 BJ Uden.
Postbus 607, 5400 AP Uden (NL).
t 0031 (0)413 - 24 6059.
e info@adezz.com, www.adezz.com

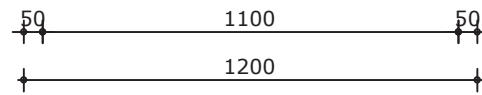
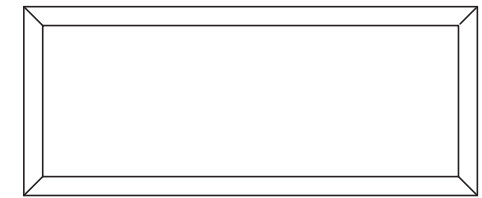

Bovenaanzicht

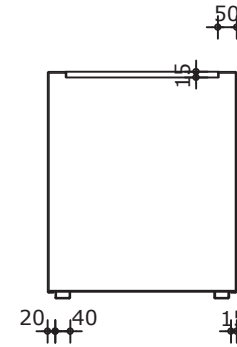

Verticale doorsnede

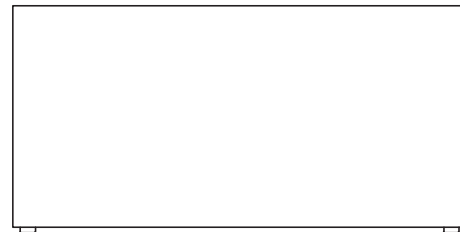

Vooraanzicht

Inhoud : 0.36m3
Gewicht : 45kg
Afwerking : Nvt

Omschrijving : Andes CA11
Opdrachtgever : Adezz
Werknnummer : Standaard
Plaats : Uden (NL)
Blad : 1/1

Get. : R. Langens
Schaal : 1:20
Datum : 01-04-2014
Wijz. :



Mandenmakerstraat 9, 5405 BJ Uden.
Postbus 607, 5400 AP Uden (NL).
t 0031 (0)413 - 24 6059.
e info@adezz.com, i www.adezz.com

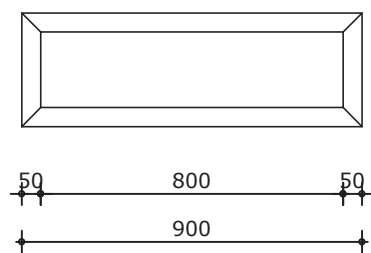

Bovenaanzicht

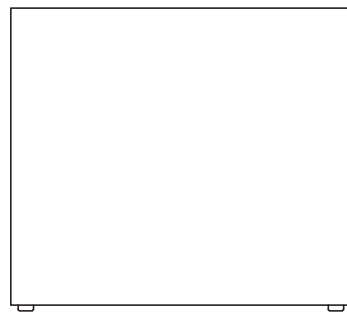

Vooraanzicht

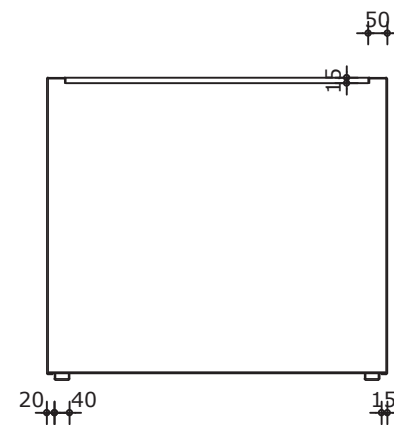

Verticale doorsnede

Inhoud : 0.22m3
 Gewicht : 37kg
 Afwerking : Nvt

| | |
|--|---|
| Omschrijving : Andes CA12 Opdrachtgever : Adezz Werknummer : Standaard Plaats : Uden (NL) Blad : 1/1 | Get. : R. Langens Schaal : 1:20 Datum : 01-04-2014 Wijz. : |
|--|---|



Mandenmakerstraat 9, 5405 BJ Uden.
 Postbus 607, 5400 AP Uden (NL).
 t 0031 (0)413 - 24 6059.
 e info@adezz.com, i www.adezz.com

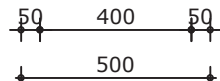
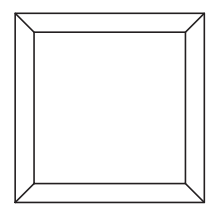

Bovenaanzicht



Verticale doorsnede

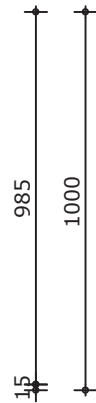
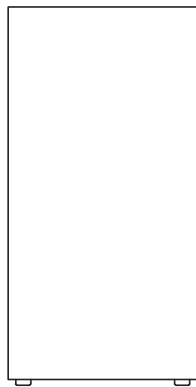

Voorbeeld

Inhoud : 0.25m3
Gewicht : 38kg
Afwerking : Nvt

Omschrijving : Andes CA13
Opdrachtgever : Adezz
Werknummer : Standaard
Plaats : Uden (NL)
Blad : 1/1

Get. : R. Langens
Schaal : 1:20
Datum : 01-04-2014
Wijz. :



Mandenmakerstraat 9, 5405 BJ Uden.
Postbus 607, 5400 AP Uden (NL).
t 0031 (0)413 - 24 6059.
e info@adezz.com, i www.adezz.com

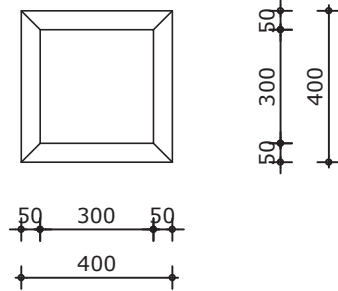

Bovenaanzicht



Verticale doorsnede

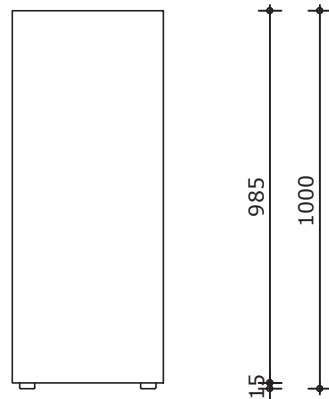

Vooraanzicht

Inhoud : 0.16m3
Gewicht : 30kg
Afwerking : Nvt

Omschrijving : Andes CA14
Opdrachtgever : Adezz
Werknummer : Standaard
Plaats : Uden (NL)
Blad : 1/1

Get. : R. Langens
Schaal : 1:20
Datum : 01-04-2014
Wijz. :



Mandenmakerstraat 9, 5405 BJ Uden.
Postbus 607, 5400 AP Uden (NL).
t 0031 (0)413 - 24 6059.
e info@adezz.com, i www.adezz.com

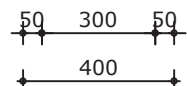
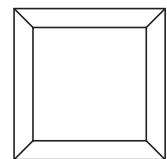

Bovenaanzicht

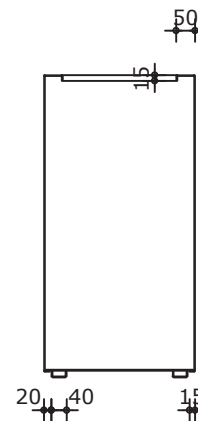
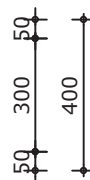

Verticale doorsnede

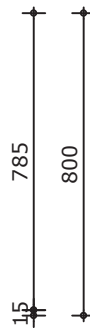
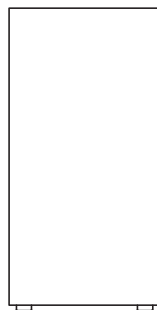

Voorbeeld

Inhoud : 0.13m3
Gewicht : 25kg
Afwerking : Nvt

Omschrijving : Andes CA15
Opdrachtgever : Adezz
Werknummer : Standaard
Plaats : Uden (NL)
Blad : 1/1

Get. : R. Langens
Schaal : 1:20
Datum : 01-04-2014
Wijz. :



Mandenmakerstraat 9, 5405 BJ Uden.
Postbus 607, 5400 AP Uden (NL).
t 0031 (0)413 - 24 6059.
e info@adezz.com, i www.adezz.com

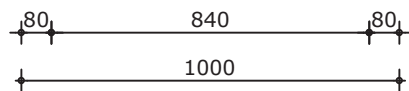
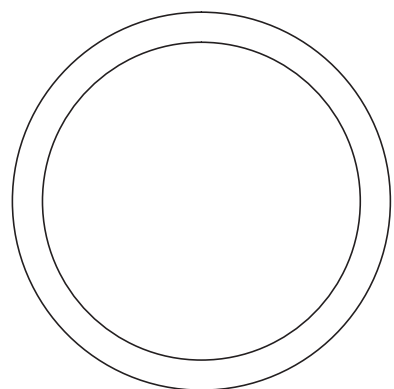

Bovenaanzicht

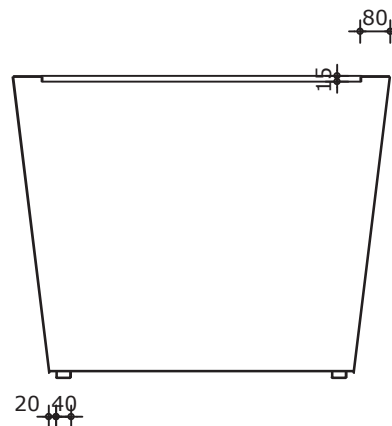

Verticale doorsnede

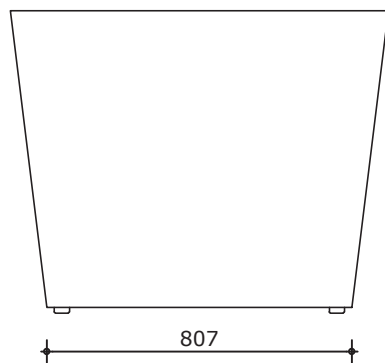

Vooraanzicht

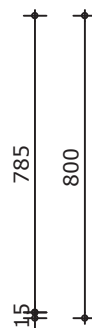

Inhoud : 0.51m3
Gewicht : 62kg
Afwerking : Nvt

Omschrijving : Cado CC1
Opdrachtgever : Adezz
Werknummer : Standaard
Plaats : Uden (NL)
Blad : 1/1

Get. : R. Langens
Schaal : 1:20
Datum : 01-04-2014
Wijz. :



Mandenmakerstraat 9, 5405 BJ Uden.
Postbus 607, 5400 AP Uden (NL).
t 0031 (0)413 - 24 6059.
e info@adezz.com, i www.adezz.com

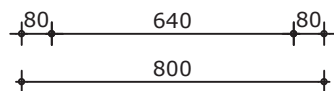
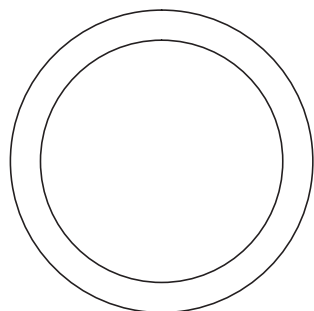

Bovenaanzicht

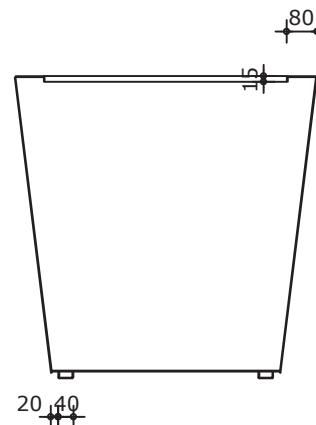

Verticale doorsnede

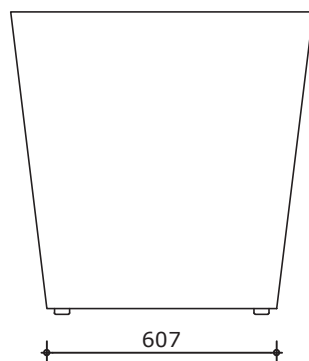

Vooraanzicht

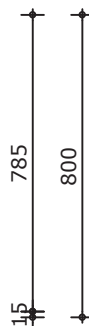

Inhoud : 0.31m3
Gewicht : 47kg
Afwerking : Nvt

Omschrijving : Cado CC2
Opdrachtgever : Adezz
Werknnummer : Standaard
Plaats : Uden (NL)
Blad : 1/1

Get. : R. Langens
Schaal : 1:20
Datum : 01-04-2014
Wijz. :



Mandenmakerstraat 9, 5405 BJ Uden.
Postbus 607, 5400 AP Uden (NL).
t 0031 (0)413 - 24 6059.
e info@adezz.com, i www.adezz.com

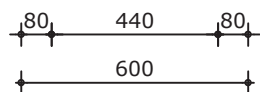
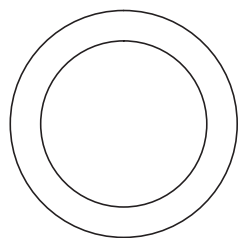

Bovenaanzicht

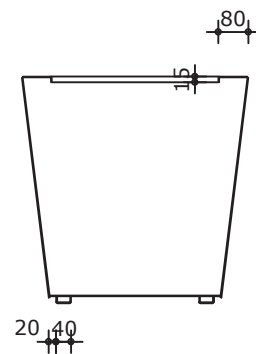

Verticale doorsnede

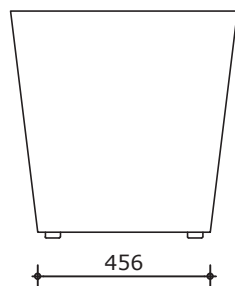

Vooraanzicht

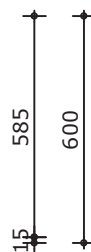

Inhoud : 0.12m3
Gewicht : 28kg
Afwerking : Nvt

Omschrijving : Cado CC3
Opdrachtgever : Adezz
Werknnummer : Standaard
Plaats : Uden (NL)
Blad : 1/1

Get. : R. Langens
Schaal : 1:20
Datum : 01-04-2014
Wijz. :



Mandenmakerstraat 9, 5405 BJ Uden.
Postbus 607, 5400 AP Uden (NL).
t 0031 (0)413 - 24 6059.
e info@adezz.com, i www.adezz.com

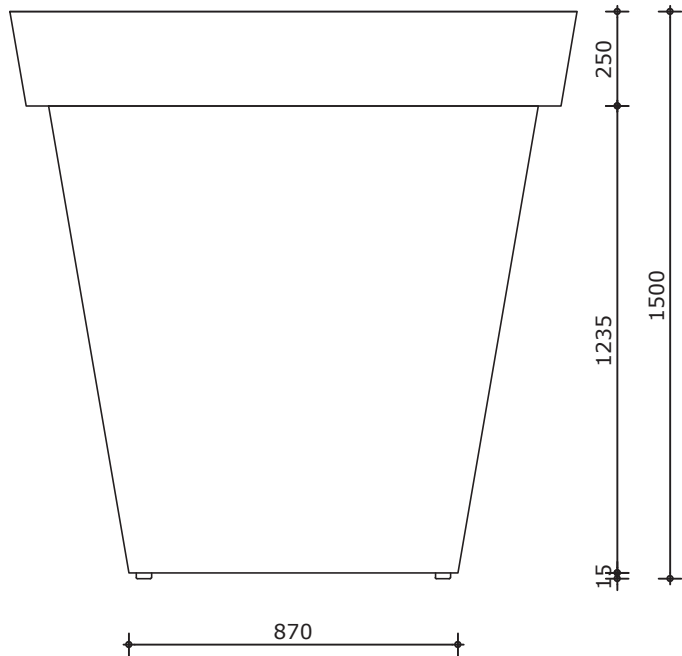

Voorraanzicht

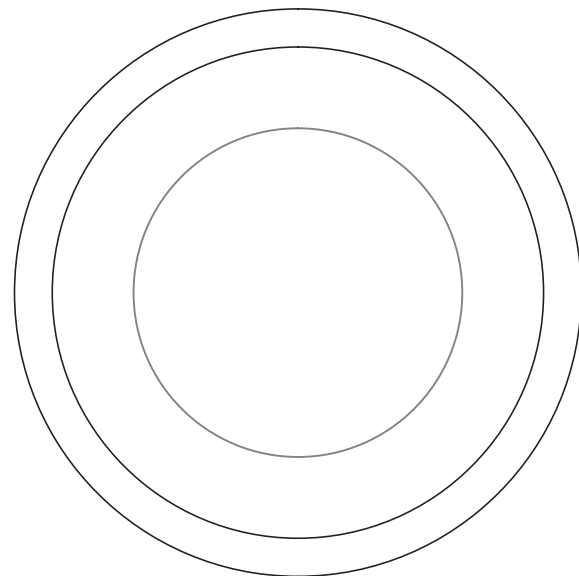

Bovenaanzicht

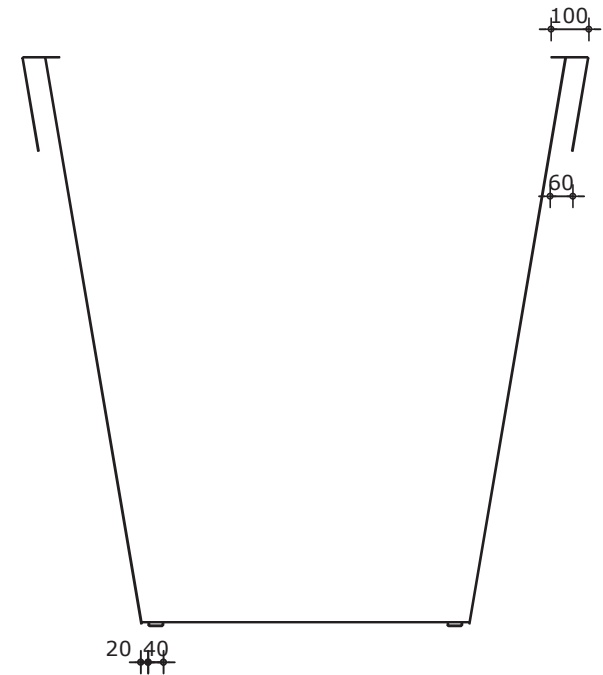

Doorsnede

Inhoud : m3
Gewicht : 145kg
Afwerking : Nvt

Omschrijving : Celso CS1
Opdrachtgever : Adezz
Werkenummer : Standaard
Plaats : Uden (NL)
Blad : 1/1

Get. : R. Langens
Schaal : 1:20
Datum : 01-04-2014
Wijz. :



Mandenmakerstraat 9, 5405 BJ Uden.
Postbus 607, 5400 AP Uden (NL).
t 0031 (0)413 - 24 6059.
e info@adezz.com, i www.adezz.com

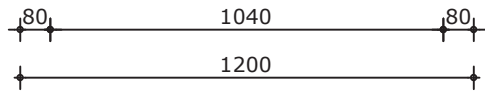
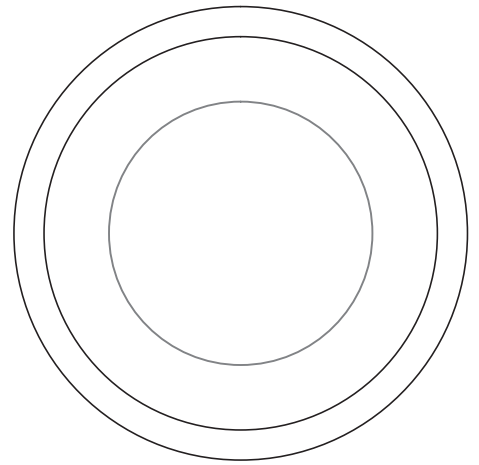

Bovenaanzicht

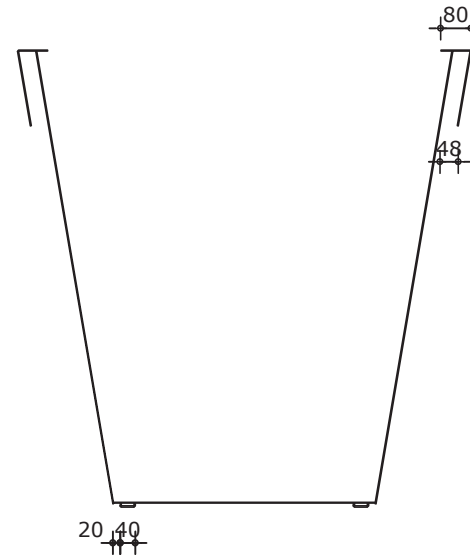

Doorsnede

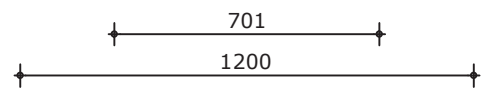
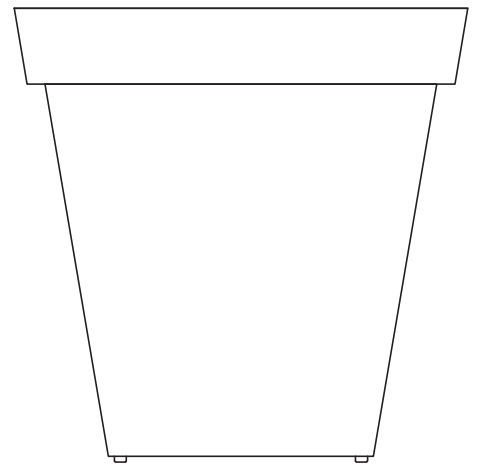

Vooraanzicht



Inhoud : m3
Gewicht : 90kg
Afwerking : Nvt

Omschrijving : Celso CS2
Opdrachtgever : Adezz
Werknummer : Standaard
Plaats : Uden (NL)
Blad : 1/1

Get. : R. Langens
Schaal : 1:20
Datum : 01-04-2014
Wijz. :



Mandenmakerstraat 9, 5405 BJ Uden.
Postbus 607, 5400 AP Uden (NL).
t 0031 (0)413 - 24 6059.
e info@adezz.com, i www.adezz.com

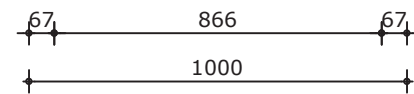
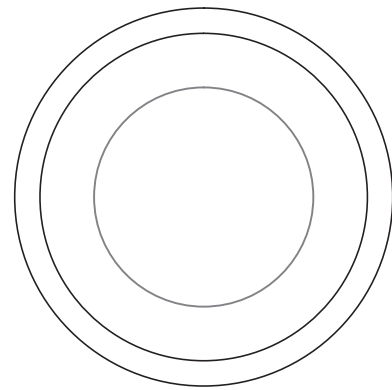

Bovenaanzicht

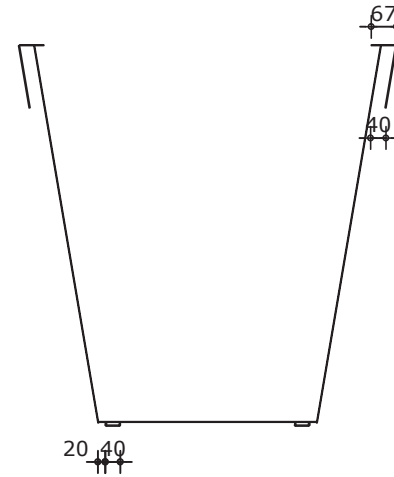

Doorsnede

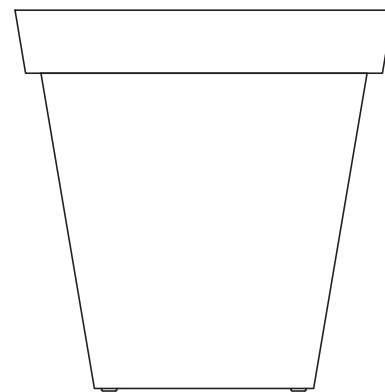

Vooraanzicht

Inhoud : m3
Gewicht : 59kg
Afwerking : Nvt

Omschrijving : Celso CS3
Opdrachtgever : Adezz
Werknnummer : Standaard
Plaats : Uden (NL)
Blad : 1/1

Get. : R. Langens
Schaal : 1:20
Datum : 01-04-2014
Wijz. :



Mandenmakerstraat 9, 5405 BJ Uden.
Postbus 607, 5400 AP Uden (NL).
t 0031 (0)413 - 24 6059.
e info@adezz.com, i www.adezz.com

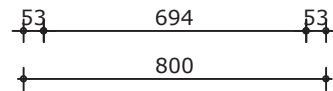
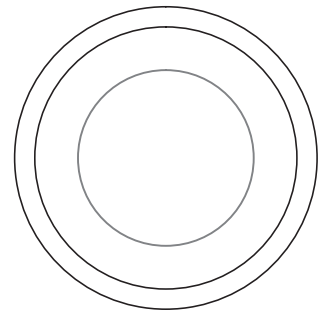

Bovenaanzicht

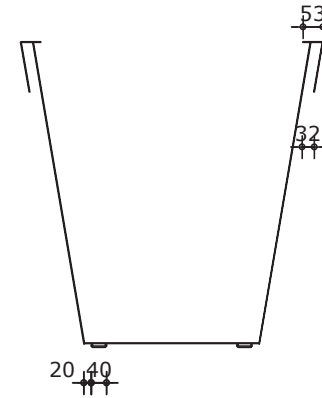

Doorsnede

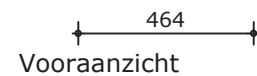
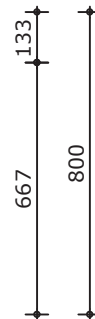
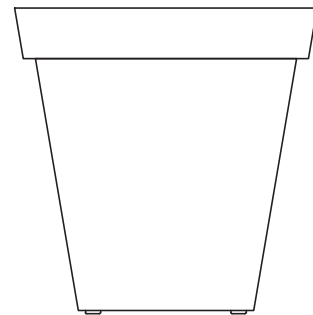

Vooraanzicht

Inhoud : m3
Gewicht : 25kg
Afwerking : Nvt

Omschrijving : Celso CS4
Opdrachtgever : Adezz
Werknummer : Standaard
Plaats : Uden (NL)
Blad : 1/1

Get. : R. Langens
Schaal : 1:20
Datum : 01-04-2014
Wijz. :



Mandenmakerstraat 9, 5405 BJ Uden.
Postbus 607, 5400 AP Uden (NL).
t 0031 (0)413 - 24 6059.
e info@adezz.com, i www.adezz.com

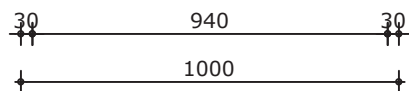
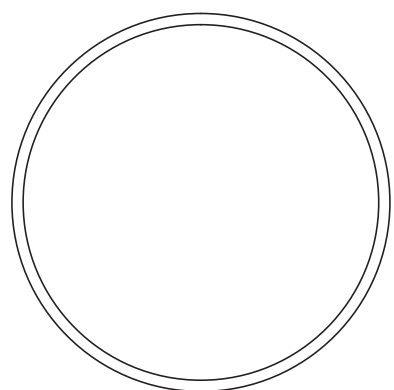

Bovenaanzicht

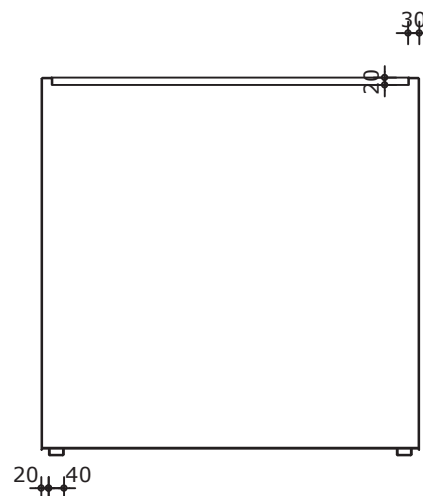

Verticale doorsnede

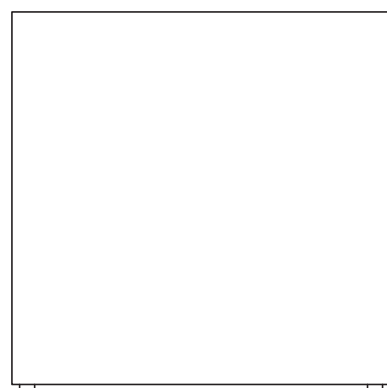

Vooraanzicht

Inhoud : 0.79m3
Gewicht : 69kg
Afwerking : Nvt

Omschrijving : Atlas CT1
Opdrachtgever : Adezz
Werknummer : Standaard
Plaats : Uden (NL)
Blad : 1/1

Get. : R. Langens
Schaal : 1:20
Datum : 01-04-2014
Wijz. :



Mandenmakerstraat 9, 5405 BJ Uden.
Postbus 607, 5400 AP Uden (NL).
t 0031 (0)413 - 24 6059.
e info@adezz.com, i www.adezz.com

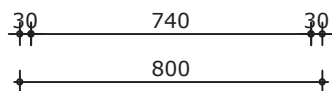
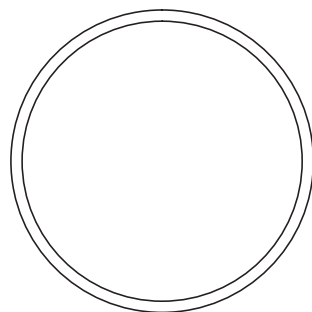

Bovenaanzicht

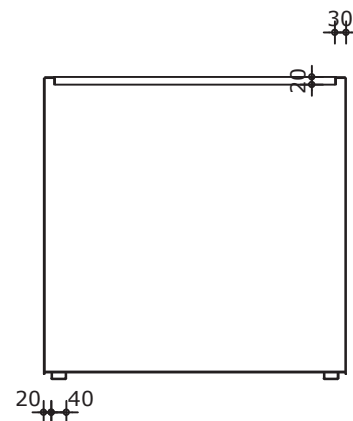

Verticale doorsnede

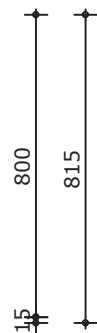
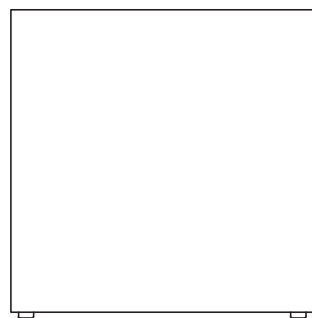

Vooraanzicht

Inhoud : 0.40m3
Gewicht : 45kg
Afwerking : Nvt

Omschrijving : Atlas CT2
Opdrachtgever : Adezz
Werknummer : Standaard
Plaats : Uden (NL)
Blad : 1/1

Get. : R. Langens
Schaal : 1:20
Datum : 01-04-2014
Wijz. :



Mandenmakerstraat 9, 5405 BJ Uden.
Postbus 607, 5400 AP Uden (NL).
t 0031 (0)413 - 24 6059.
e info@adezz.com, i www.adezz.com

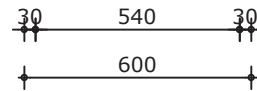
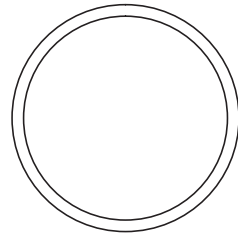

Bovenaanzicht

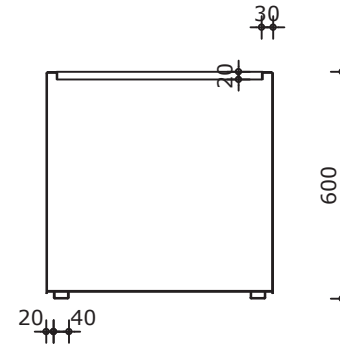

Verticale doorsnede

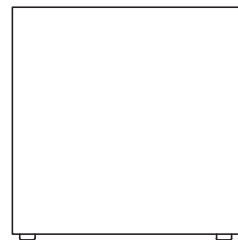

Vooraanzicht

Inhoud : 0.17m3
Gewicht : 26kg
Afwerking : Nvt

Omschrijving : Atlas CT3
Opdrachtgever : Adezz
Werknummer : Standaard
Plaats : Uden (NL)
Blad : 1/1

Get. : R. Langens
Schaal : 1:20
Datum : 01-04-2014
Wijz. :



Mandenmakerstraat 9, 5405 BJ Uden.
Postbus 607, 5400 AP Uden (NL).
t 0031 (0)413 - 24 6059.
e info@adezz.com, i www.adezz.com

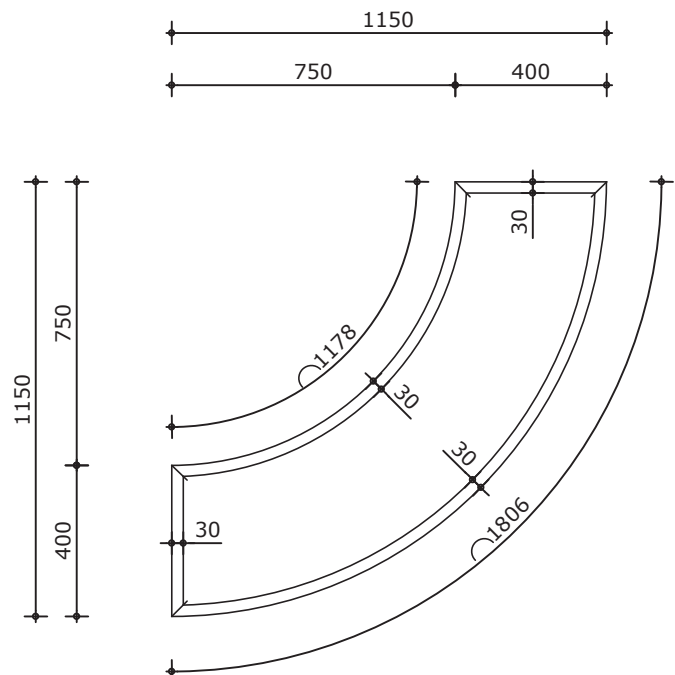

Bovenaanzicht

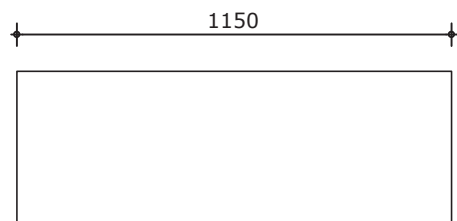

Vooraanzicht

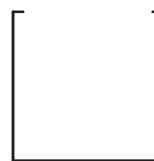

Verticale doorsnede

Inhoud : 0.24m3
 Gewicht : 60kg
 Afwerking : Nvt

| | |
|--------------------------|--------------------|
| Omschrijving : Carpa CR1 | Get. : R. Langens |
| Opdrachtgever : Adezz | Schaal : 1:20 |
| Werknummer : Standaard | Datum : 01-04-2014 |
| Plaats : Uden (NL) | Wijz. : |
| Blad : 1/1 | |



Mandenmakerstraat 9, 5405 BJ Uden.
 Postbus 607, 5400 AP Uden (NL).
 t 0031 (0)413 - 24 6059.
 e info@adezz.com, i www.adezz.com

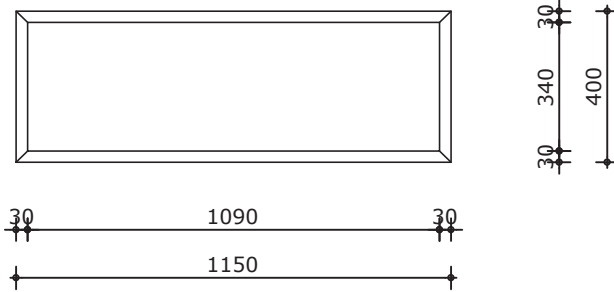

Bovenaanzicht

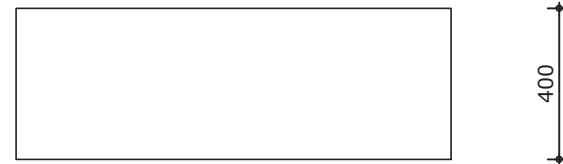

Vooraanzicht

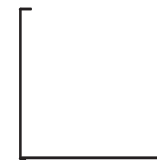

Verticale doorsnede

Inhoud : 0.18m3
 Gewicht : 45kg
 Afwerking : Nvt

Omschrijving : Carpa CR2
 Opdrachtgever : Adezz
 Werknummer : Standaard
 Plaats : Uden (NL)
 Blad : 1/1

Get. : R. Langens
 Schaal : 1:20
 Datum : 01-04-2014
 Wijz. :



Mandenmakerstraat 9, 5405 BJ Uden.
 Postbus 607, 5400 AP Uden (NL).
 t 0031 (0)413 - 24 6059.
 e info@adezz.com, i www.adezz.com

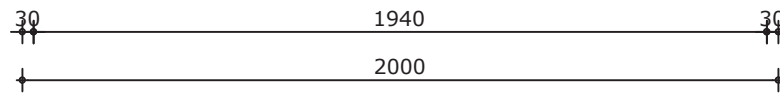
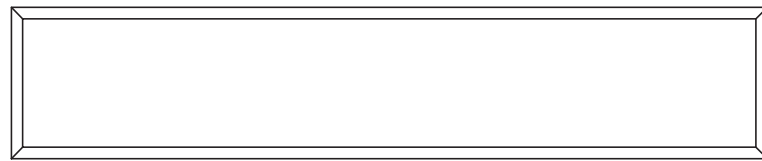

Bovenaanzicht



Vooraanzicht

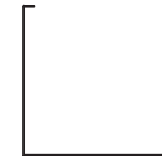

Verticale doorsnede

Inhoud : 0.32m3
Gewicht : 72kg
Afwerking : Nvt

Omschrijving : Carpa CR3
Opdrachtgever : Adezz
Werknummer : Standaard
Plaats : Uden (NL)
Blad : 1/1

Get. : R. Langens
Schaal : 1:20
Datum : 01-04-2014
Wijz. :



Mandenmakerstraat 9, 5405 BJ Uden.
Postbus 607, 5400 AP Uden (NL).
t 0031 (0)413 - 24 6059.
e info@adezz.com, i www.adezz.com

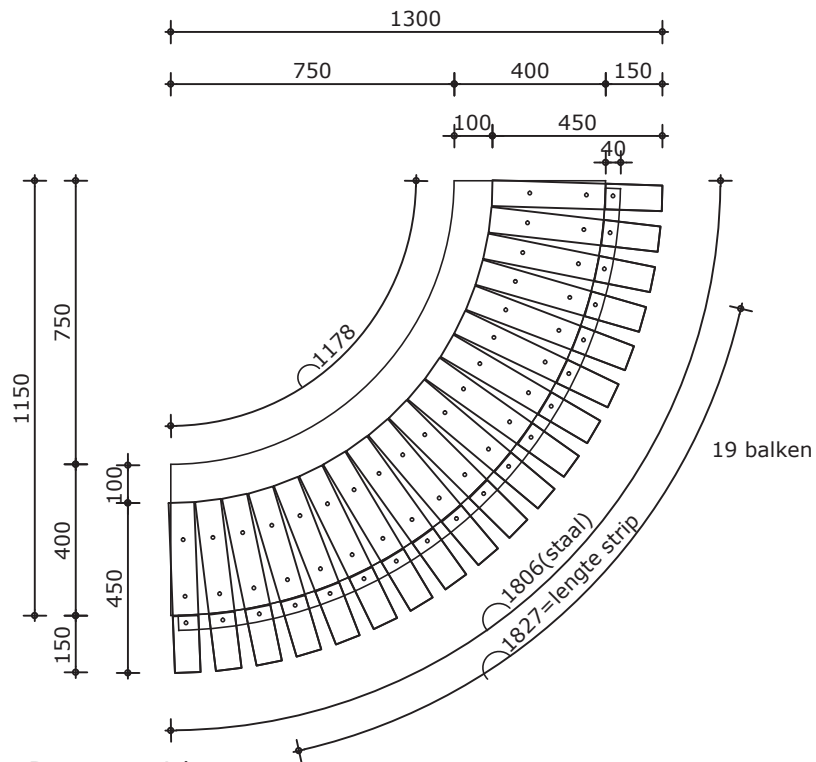

Bovenaanzicht

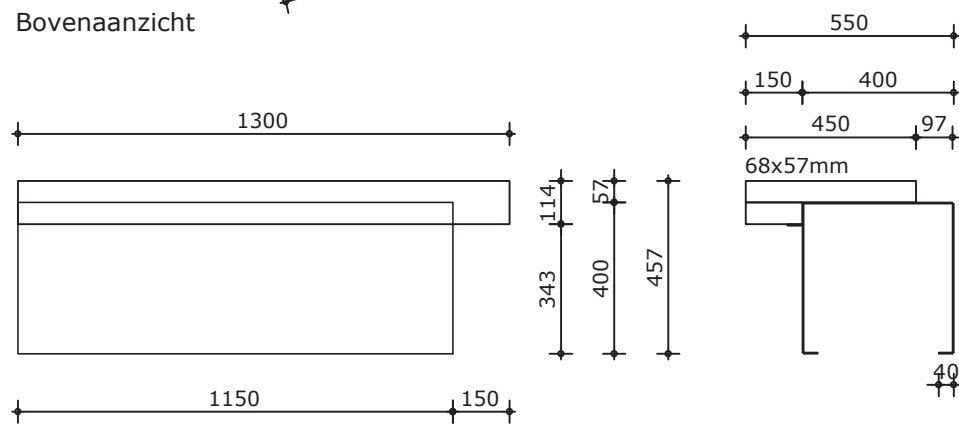

Vooraanzicht

Verticale doorsnede

Gewicht : 96kg
Afwerking : Nvt

Omschrijving : Carpa CRH1
Opdrachtgever : Adezz
Werknummer : Standaard
Plaats : Uden (NL)
Blad : 1/1

Get. : R. Langens
Schaal : 1:20
Datum : 01-04-2014
Wijz. :



Mandenmakerstraat 9, 5405 BJ Uden.
Postbus 607, 5400 AP Uden (NL).
t 0031 (0)413 - 24 6059.
e info@adezz.com, i www.adezz.com

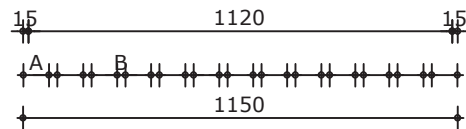
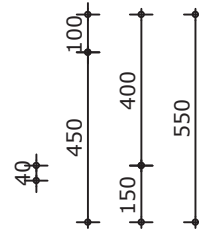

13xA A=68mm
12xB B=12mm

Bovenaanzicht

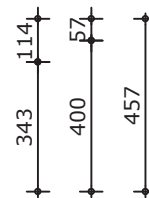
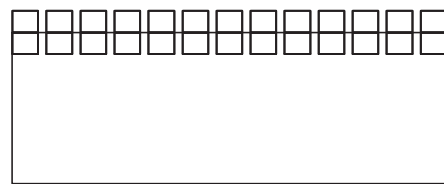

Voorraanzicht

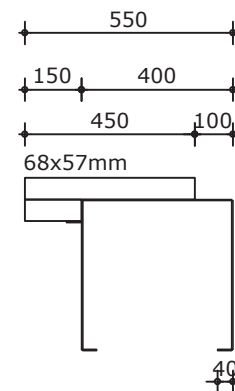

Verticale doorsnede

Gewicht : 93kg
Afwerking : Nvt

Omschrijving : Carpa CRH2
Opdrachtgever : Adezz
Werknummer : Standaard
Plaats : Uden (NL)
Blad : 1/1

Get. : R. Langens
Schaal : 1:20
Datum : 01-04-2014
Wijz. :



Mandenmakerstraat 9, 5405 BJ Uden.
Postbus 607, 5400 AP Uden (NL).
t 0031 (0)413 - 24 6059.
e info@adezz.com, i www.adezz.com

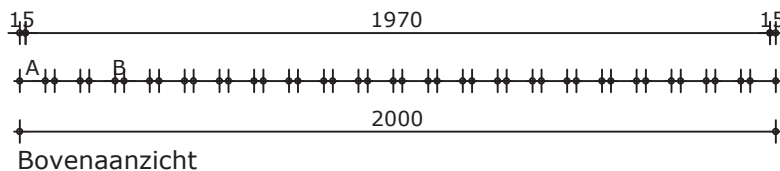

Bovenaanzicht

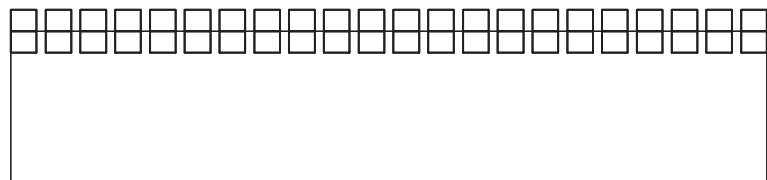

Vooraanzicht

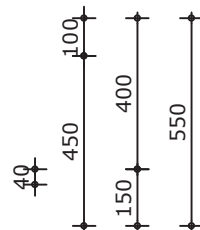

22xA A=68mm
21xB B=24mm

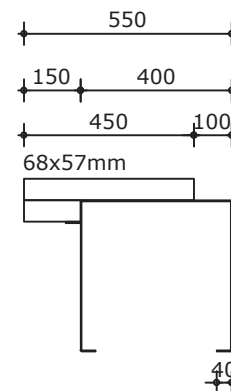

Verticale doorsnede

Gewicht : 122kg
Afwerking : Nvt

Omschrijving : Carpa CRH3
Opdrachtgever : Adezz
Werknummer : Standaard
Plaats : Uden (NL)
Blad : 1/1

Get. : R. Langens
Schaal : 1:20
Datum : 01-04-2014
Wijz. :



Mandenmakerstraat 9, 5405 BJ Uden.
Postbus 607, 5400 AP Uden (NL).
t 0031 (0)413 - 24 6059.
e info@adezz.com, i www.adezz.com

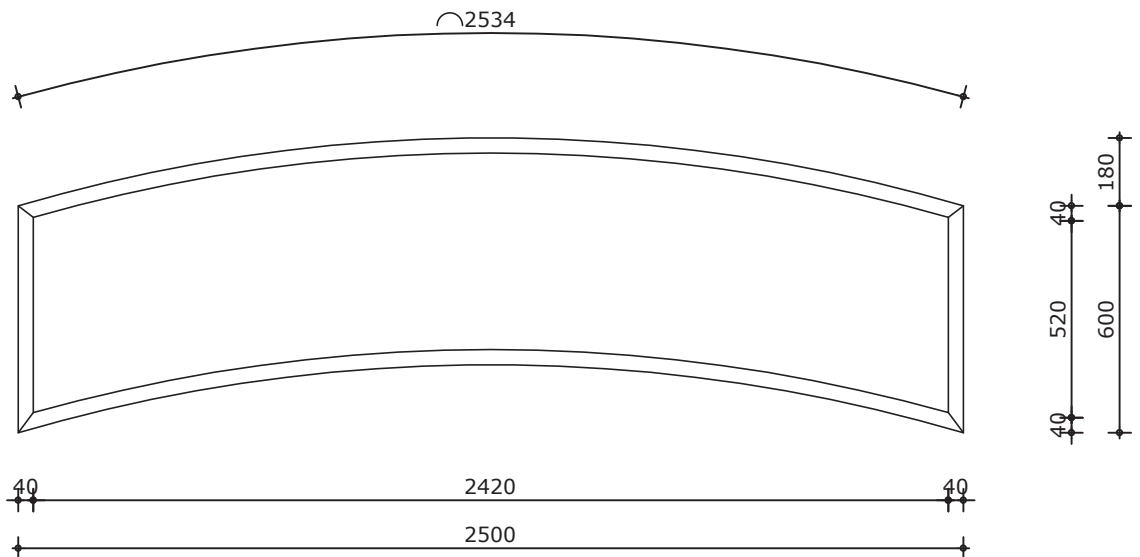

Bovenaanzicht

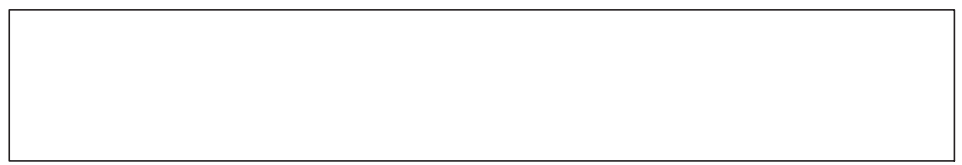

Vooraanzicht

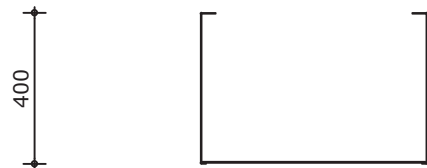

Verticale doorsnede

Inhoud : 0.68m3
 Gewicht : 107kg
 Afwerking : Nvt

| | |
|---|---|
| Omschrijving : Carva CV1 Opdrachtgever : Adezz Werknummer : Standaard Plaats : Uden (NL) Blad : 1/1 | Get. : R. Langens Schaal : 1:20 Datum : 01-04-2014 Wijz. : |
|---|---|



Mandenmakerstraat 9, 5405 BJ Uden.
 Postbus 607, 5400 AP Uden (NL).
 t 0031 (0)413 - 24 6059.
 e info@adezz.com, i www.adezz.com

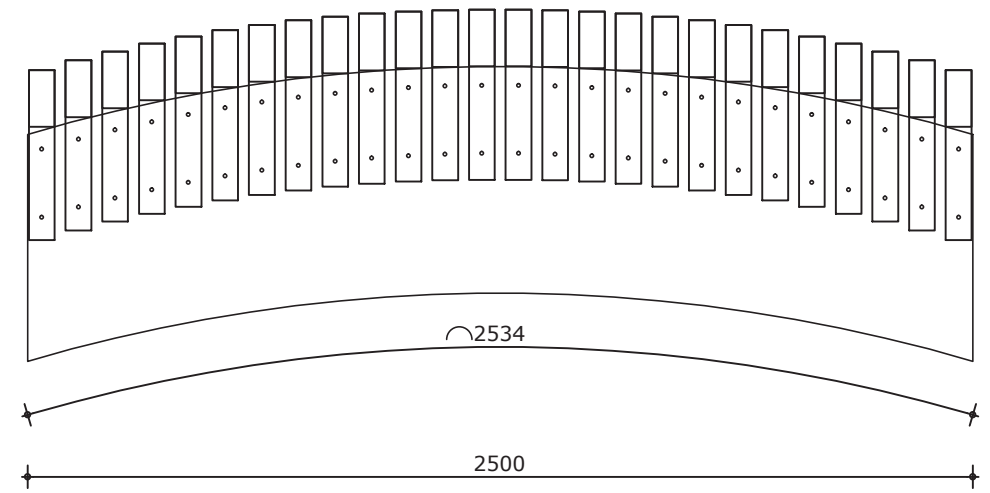

Bovenaanzicht

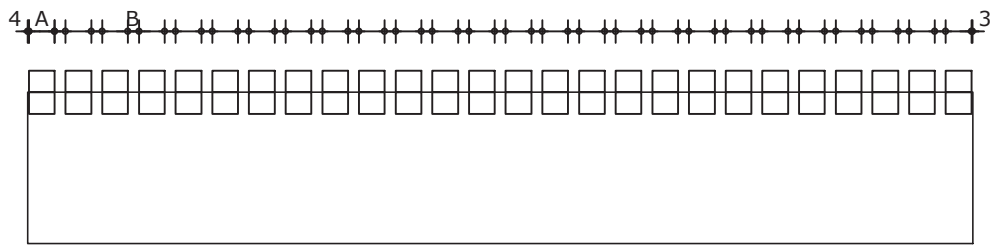

Vooraanzicht

26xA A=68mm
25xB B=29mm

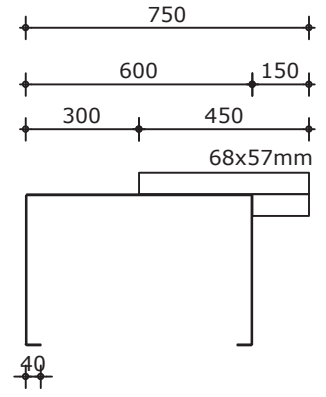

Verticale doorsnede

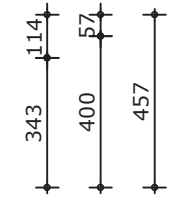

Gewicht : 242kg
Afwerking : Nvt

| | |
|---------------------------|--------------------|
| Omschrijving : Carva CVH1 | Get. : R. Langens |
| Opdrachtgever : Adezz | Schaal : 1:20 |
| Werknummer : Standaard | Datum : 01-04-2014 |
| Plaats : Uden (NL) | Wijz. : |
| Blad : 1/1 | |



Mandenmakerstraat 9, 5405 BJ Uden.
Postbus 607, 5400 AP Uden (NL).
t 0031 (0)413 - 24 6059.
e info@adezz.com, i www.adezz.com

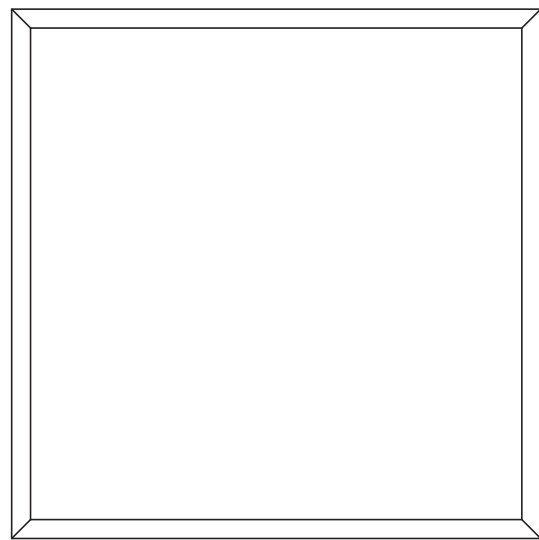

50
1300
1400
50

50 1300 50
1400

Bovenaanzicht

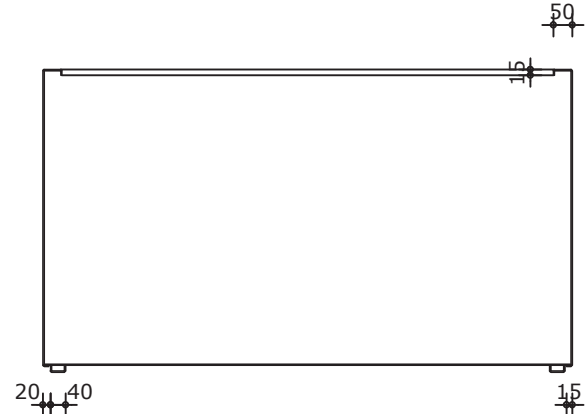

Verticale doorsnede

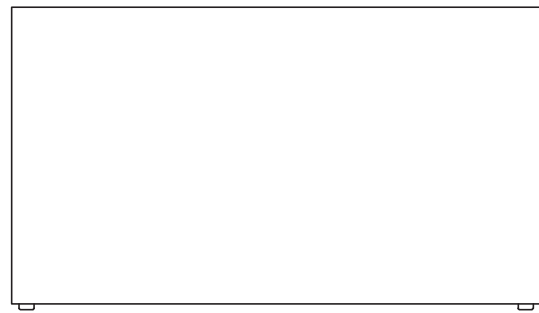

785
800
15

Vooraanzicht

Inhoud : 1.57m3
Gewicht : 112kg
Afwerking : Nvt

| | |
|--------------------------|--------------------|
| Omschrijving : Andes CA1 | Get. : R. Langens |
| Opdrachtgever : Adezz | Schaal : 1:20 |
| Werknummer : Standaard | Datum : 01-04-2014 |
| Plaats : Uden (NL) | Wijz. : |
| Blad : 1/1 | |



Mandenmakerstraat 9, 5405 BJ Uden.
Postbus 607, 5400 AP Uden (NL).
t 0031 (0)413 - 24 6059.
e info@adezz.com, i www.adezz.com

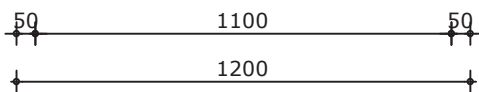
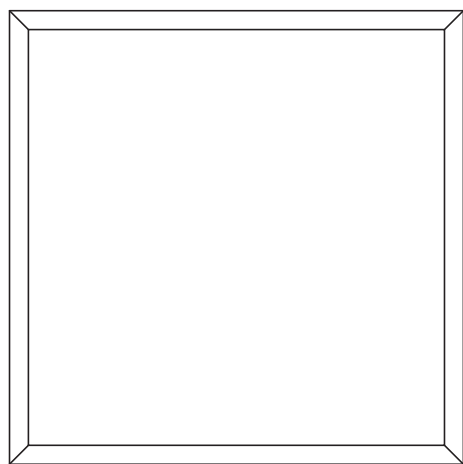

Bovenaanzicht

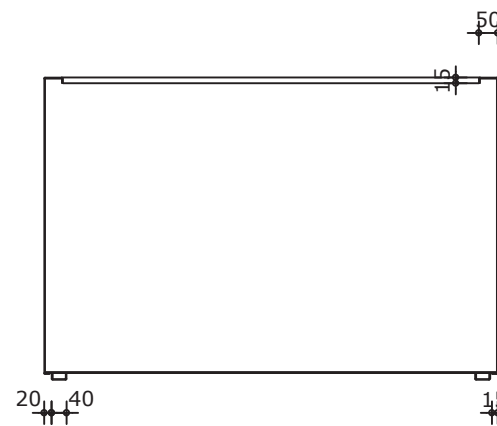

Verticale doorsnede



Voorraanzicht

Inhoud : 1.15m3
Gewicht : 93kg
Afwerking : Nvt

Omschrijving : Andes CA2
Opdrachtgever : Adezz
Werknummer : Standaard
Plaats : Uden (NL)
Blad : 1/1

Get. : R. Langens
Schaal : 1:20
Datum : 01-04-2014
Wijz. :



Mandenmakerstraat 9, 5405 BJ Uden.
Postbus 607, 5400 AP Uden (NL).
t 0031 (0)413 - 24 6059.
e info@adezz.com, i www.adezz.com

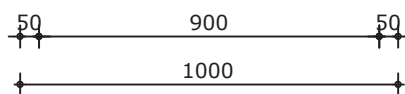
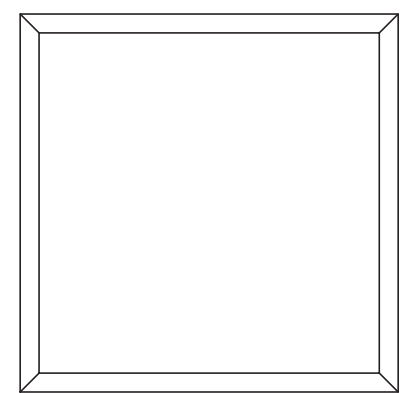

Bovenaanzicht

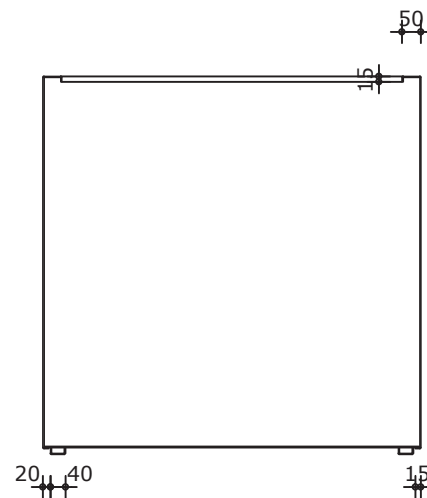

Verticale doorsnede

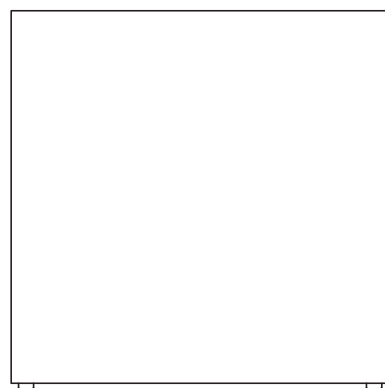

Vooraanzicht



Inhoud : 1.00m3
Gewicht : 89kg
Afwerking : Nvt

Omschrijving : Andes CA3
Opdrachtgever : Adezz
Werknummer : Standaard
Plaats : Uden (NL)
Blad : 1/1

Get. : R. Langens
Schaal : 1:20
Datum : 01-04-2014
Wijz. :



Mandenmakerstraat 9, 5405 BJ Uden.
Postbus 607, 5400 AP Uden (NL).
t 0031 (0)413 - 24 6059.
e info@adezz.com, i www.adezz.com

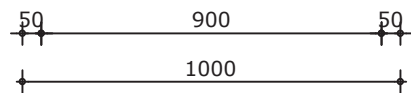
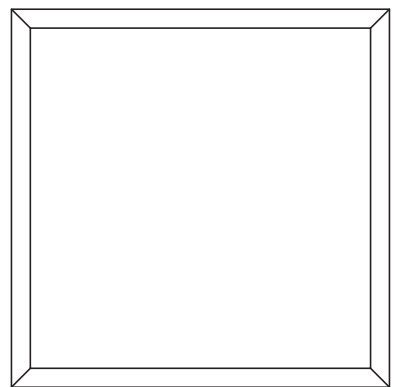

Bovenaanzicht

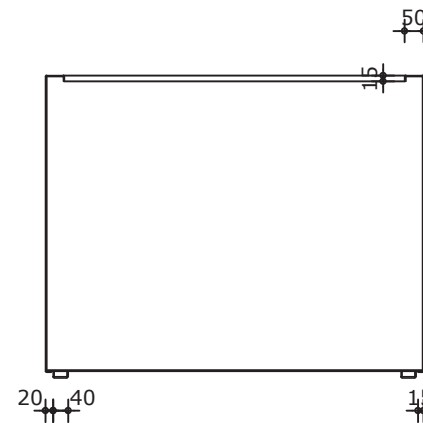
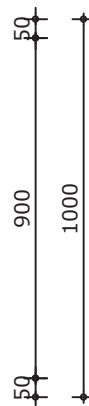

Verticale doorsnede

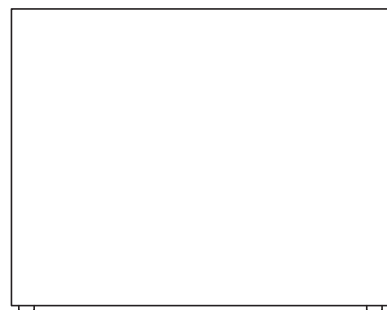

Vooraanzicht

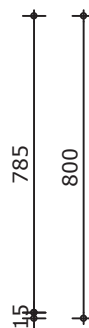

Inhoud : 0.80m3
Gewicht : 75kg
Afwerking : Nvt

Omschrijving : Andes CA4
Opdrachtgever : Adezz
Werknnummer : Standaard
Plaats : Uden (NL)
Blad : 1/1

Get. : R. Langens
Schaal : 1:20
Datum : 01-04-2014
Wijz. :



Mandenmakerstraat 9, 5405 BJ Uden.
Postbus 607, 5400 AP Uden (NL).
t 0031 (0)413 - 24 6059.
e info@adezz.com, i www.adezz.com

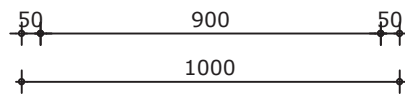
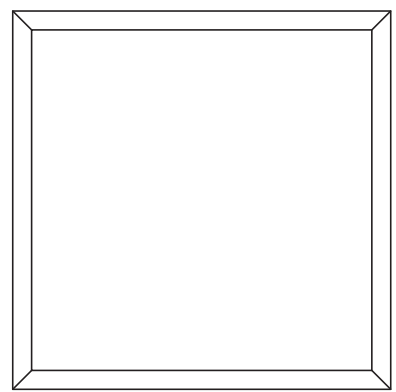

Bovenaanzicht

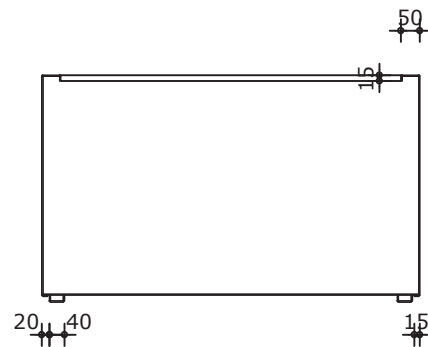

Verticale doorsnede



Vooraanzicht

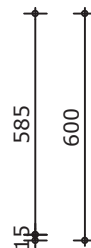

Inhoud : 0.60m3
Gewicht : 60kg
Afwerking : Nvt

Omschrijving : Andes CA4.1
Opdrachtgever : Adezz
Werknnummer : Standaard
Plaats : Uden (NL)
Blad : 1/1

Get. : R. Langens
Schaal : 1:20
Datum : 01-04-2014
Wijz. :



Mandenmakerstraat 9, 5405 BJ Uden.
Postbus 607, 5400 AP Uden (NL).
t 0031 (0)413 - 24 6059.
e info@adezz.com, i www.adezz.com

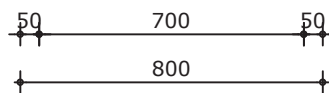
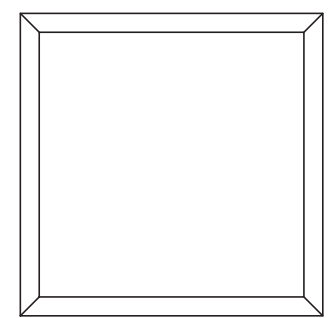

Bovenaanzicht

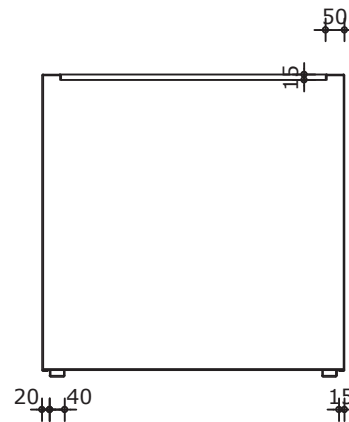

Verticale doorsnede

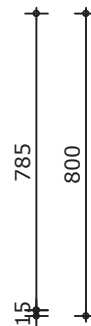
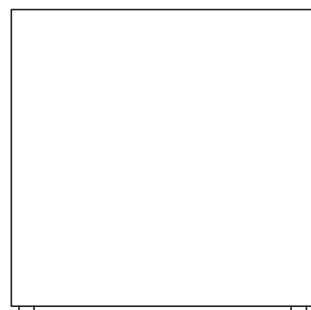

Vooraanzicht

Inhoud : 0.51m3
Gewicht : 54kg
Afwerking : Nvt

Omschrijving : Andes CA5
Opdrachtgever : Adezz
Werknnummer : Standaard
Plaats : Uden (NL)
Blad : 1/1

Get. : R. Langens
Schaal : 1:20
Datum : 01-04-2014
Wijz. :



Mandenmakerstraat 9, 5405 BJ Uden.
Postbus 607, 5400 AP Uden (NL).
t 0031 (0)413 - 24 6059.
e info@adezz.com, i www.adezz.com

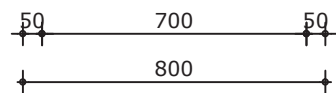
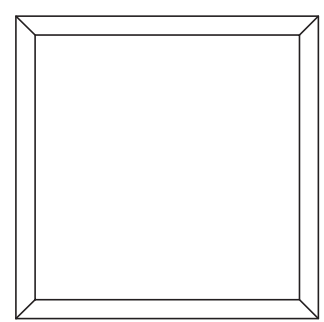

Bovenaanzicht

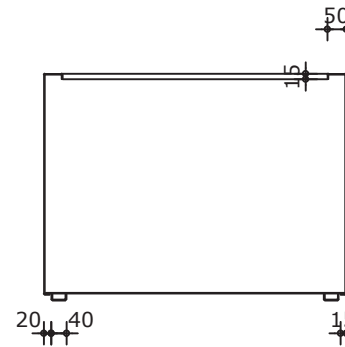
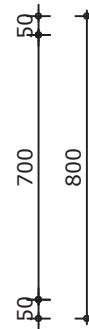

Verticale doorsnede

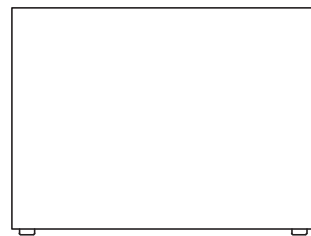

Vooraanzicht

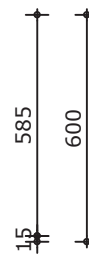

Inhoud : 0.38m3
Gewicht : 44kg
Afwerking : Nvt

Omschrijving : Andes CA5.1
Opdrachtgever : Adezz
Werknnummer : Standaard
Plaats : Uden (NL)
Blad : 1/1

Get. : R. Langens
Schaal : 1:20
Datum : 01-04-2014
Wijz. :



Mandenmakerstraat 9, 5405 BJ Uden.
Postbus 607, 5400 AP Uden (NL).
t 0031 (0)413 - 24 6059.
e info@adezz.com, i www.adezz.com

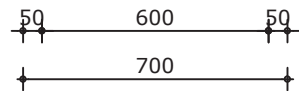
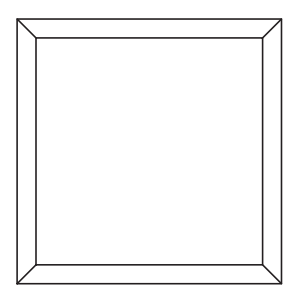

Bovenaanzicht

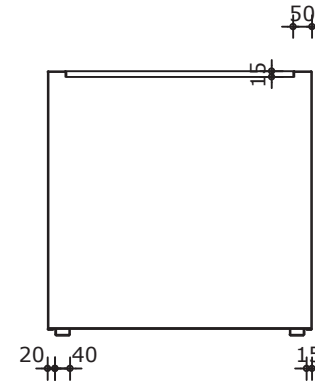

Verticale doorsnede

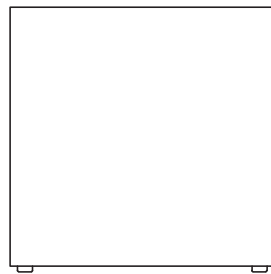

Vooraanzicht



Inhoud : 0.34m3
Gewicht : 42kg
Afwerking : Nvt

Omschrijving : Andes CA6
Opdrachtgever : Adezz
Werknummer : Standaard
Plaats : Uden (NL)
Blad : 1/1

Get. : R. Langens
Schaal : 1:20
Datum : 01-04-2014
Wijz. :



Mandenmakerstraat 9, 5405 BJ Uden.
Postbus 607, 5400 AP Uden (NL).
t 0031 (0)413 - 24 6059.
e info@adezz.com, i www.adezz.com

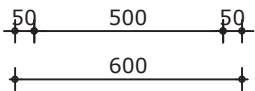
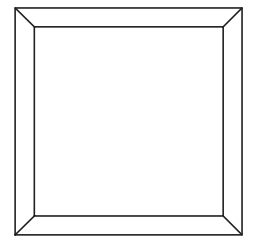

Bovenaanzicht

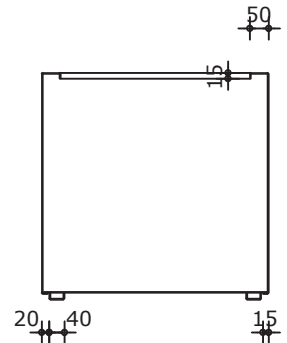

Verticale doorsnede

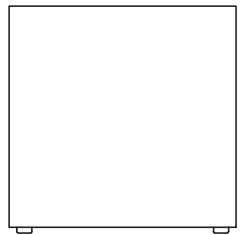

Vooraanzicht



Inhoud : 0.22m3
Gewicht : 31 kg
Afwerking : Nvt

| | |
|--------------------------|--------------------|
| Omschrijving : Andes CA7 | Get. : R. Langens |
| Opdrachtgever : Adezz | Schaal : 1:20 |
| Werknummer : Standaard | Datum : 01-04-2014 |
| Plaats : Uden (NL) | Wijz. : |
| Blad : 1/1 | |



Mandenmakerstraat 9, 5405 BJ Uden.
Postbus 607, 5400 AP Uden (NL).
t 0031 (0)413 - 24 6059.
e info@adezz.com, i www.adezz.com

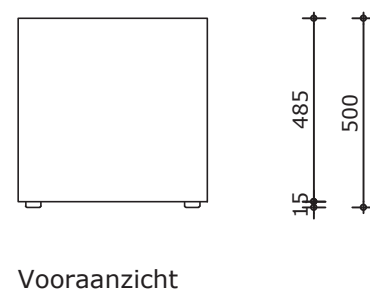
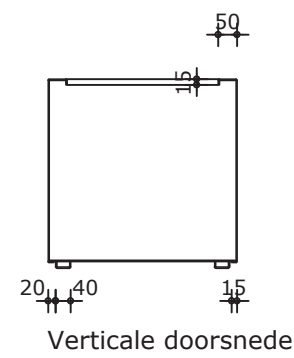
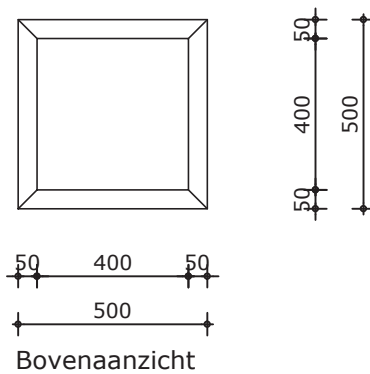

Inhoud : 0.13m3
 Gewicht : 22kg
 Afwerking : Nvt

| | |
|--------------------------|--------------------|
| Omschrijving : Andes CA8 | Get. : R. Langens |
| Opdrachtgever : Adezz | Schaal : 1:20 |
| Werknummer : Standaard | Datum : 01-04-2014 |
| Plaats : Uden (NL) | Wijz. : |
| Blad : 1/1 | |



Mandenmakerstraat 9, 5405 BJ Uden.
 Postbus 607, 5400 AP Uden (NL).
 t 0031 (0)413 - 24 6059.
 e info@adezz.com, i www.adezz.com

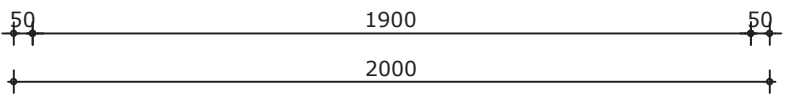
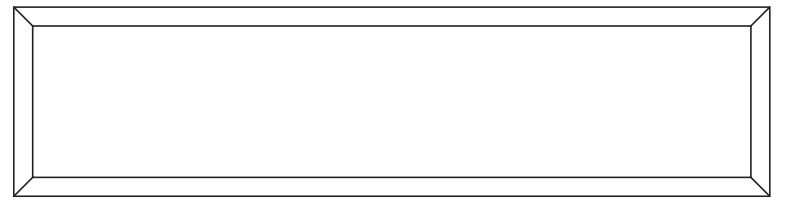

Bovenaanzicht

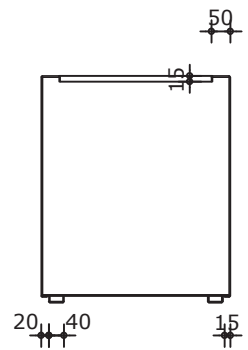

Verticale doorsnede

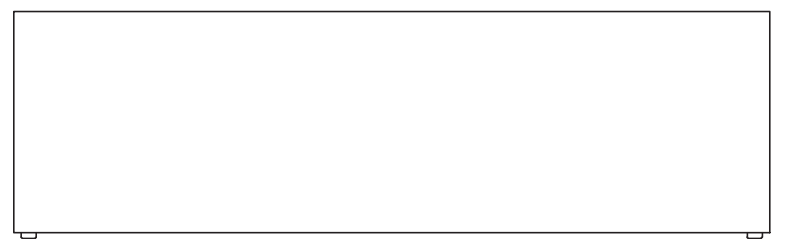

Vooraanzicht

Inhoud : 0.60m3
Gewicht : 69kg
Afwerking : Nvt

| | |
|--------------------------|--------------------|
| Omschrijving : Andes CA9 | Get. : R. Langens |
| Opdrachtgever : Adezz | Schaal : 1:20 |
| Werknummer : Standaard | Datum : 01-04-2014 |
| Plaats : Uden (NL) | Wijz. : |
| Blad : 1/1 | |



Mandenmakerstraat 9, 5405 BJ Uden.
Postbus 607, 5400 AP Uden (NL).
t 0031 (0)413 - 24 6059.
e info@adezz.com, i www.adezz.com

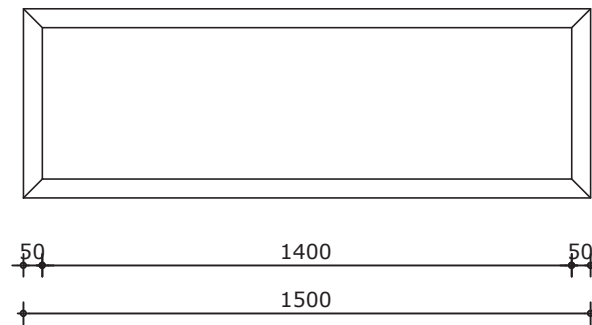

Bovenaanzicht

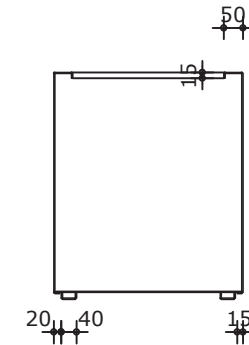

Verticale doorsnede



Vooraanzicht



Inhoud : 0.45m3
Gewicht : 54kg
Afwerking : Nvt

Omschrijving : Andes CA10
Opdrachtgever : Adezz
Werknummer : Standaard
Plaats : Uden (NL)
Blad : 1/1

Get. : R. Langens
Schaal : 1:20
Datum : 01-04-2014
Wijz. :



Mandenmakerstraat 9, 5405 BJ Uden.
Postbus 607, 5400 AP Uden (NL).
t 0031 (0)413 - 24 6059.
e info@adezz.com, i www.adezz.com

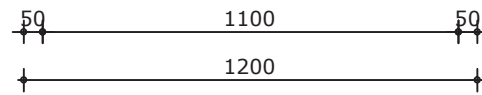
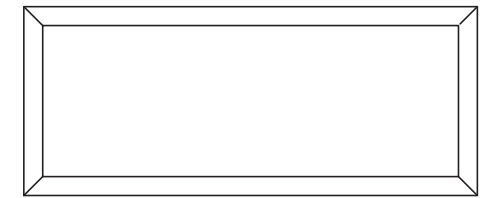

Bovenaanzicht

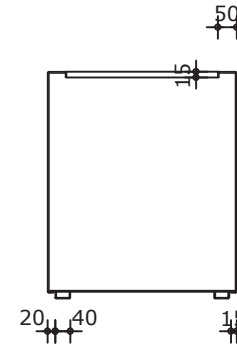

Verticale doorsnede

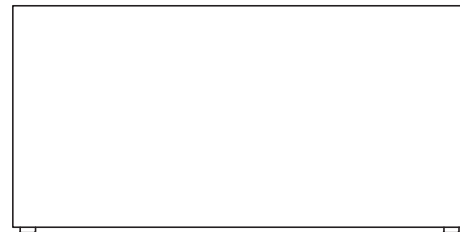

Vooraanzicht

Inhoud : 0.36m3
Gewicht : 45kg
Afwerking : Nvt

Omschrijving : Andes CA11
Opdrachtgever : Adezz
Werknnummer : Standaard
Plaats : Uden (NL)
Blad : 1/1

Get. : R. Langens
Schaal : 1:20
Datum : 01-04-2014
Wijz. :



Mandenmakerstraat 9, 5405 BJ Uden.
Postbus 607, 5400 AP Uden (NL).
t 0031 (0)413 - 24 6059.
e info@adezz.com, i www.adezz.com

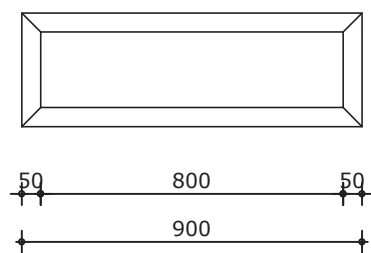

Bovenaanzicht

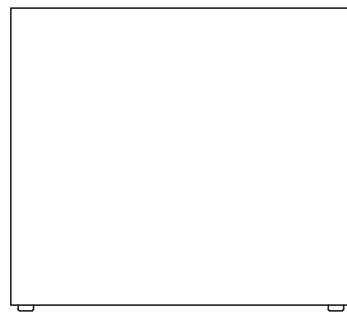

Vooraanzicht

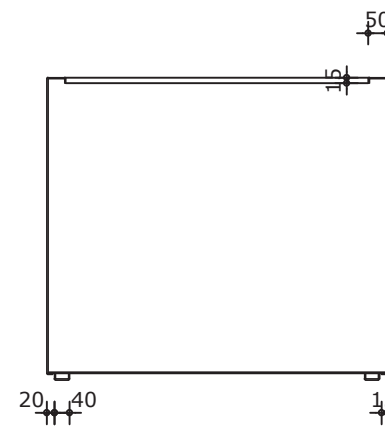

Verticale doorsnede

Inhoud : 0.22m3
Gewicht : 37kg
Afwerking : Nvt

Omschrijving : Andes CA12
Opdrachtgever : Adezz
Werknummer : Standaard
Plaats : Uden (NL)
Blad : 1/1

Get. : R. Langens
Schaal : 1:20
Datum : 01-04-2014
Wijz. :



Mandenmakerstraat 9, 5405 BJ Uden.
Postbus 607, 5400 AP Uden (NL).
t 0031 (0)413 - 24 6059.
e info@adezz.com, i www.adezz.com

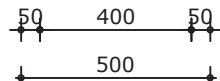
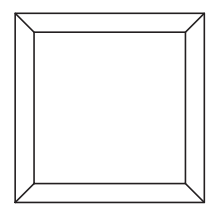

Bovenaanzicht



Verticale doorsnede

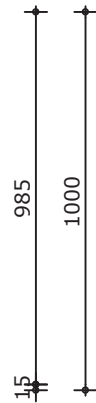
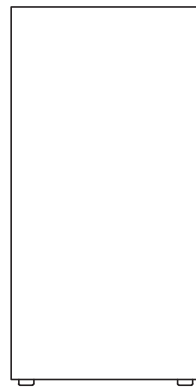

Voorbeeld

Inhoud : 0.25m3
Gewicht : 38kg
Afwerking : Nvt

Omschrijving : Andes CA13
Opdrachtgever : Adezz
Werknummer : Standaard
Plaats : Uden (NL)
Blad : 1/1

Get. : R. Langens
Schaal : 1:20
Datum : 01-04-2014
Wijz. :



Mandenmakerstraat 9, 5405 BJ Uden.
Postbus 607, 5400 AP Uden (NL).
t 0031 (0)413 - 24 6059.
e info@adezz.com, i www.adezz.com

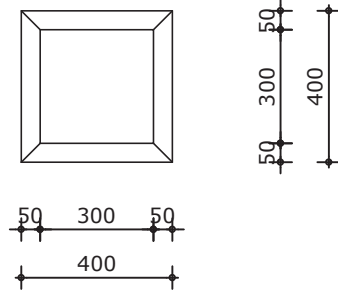

Bovenaanzicht



Verticale doorsnede

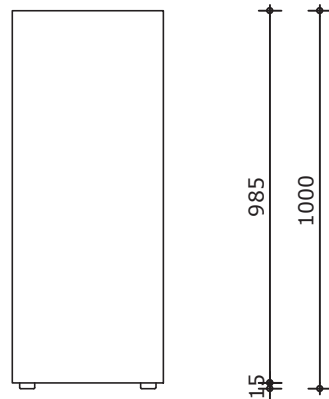

Vooraanzicht

Inhoud : 0.16m3
Gewicht : 30kg
Afwerking : Nvt

Omschrijving : Andes CA14
Opdrachtgever : Adezz
Werknnummer : Standaard
Plaats : Uden (NL)
Blad : 1/1

Get. : R. Langens
Schaal : 1:20
Datum : 01-04-2014
Wijz. :



Mandenmakerstraat 9, 5405 BJ Uden.
Postbus 607, 5400 AP Uden (NL).
t 0031 (0)413 - 24 6059.
e info@adezz.com, i www.adezz.com

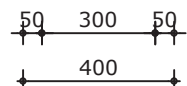
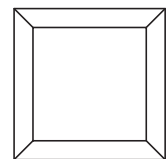

Bovenaanzicht

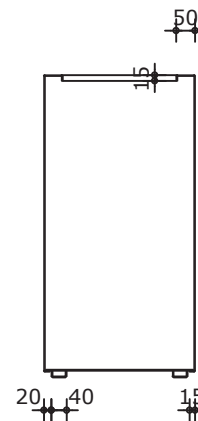
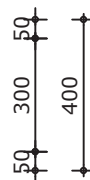

Verticale doorsnede



Voorbeeld

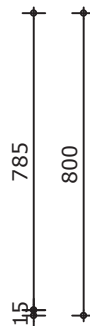

Inhoud : 0.13m3
Gewicht : 25kg
Afwerking : Nvt

Omschrijving : Andes CA15
Opdrachtgever : Adezz
Werknummer : Standaard
Plaats : Uden (NL)
Blad : 1/1

Get. : R. Langens
Schaal : 1:20
Datum : 01-04-2014
Wijz. :



Mandenmakerstraat 9, 5405 BJ Uden.
Postbus 607, 5400 AP Uden (NL).
t 0031 (0)413 - 24 6059.
e info@adezz.com, i www.adezz.com

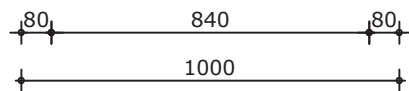
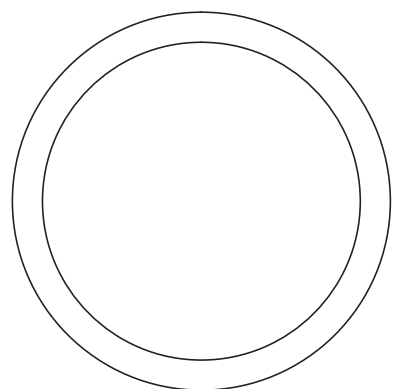

Bovenaanzicht

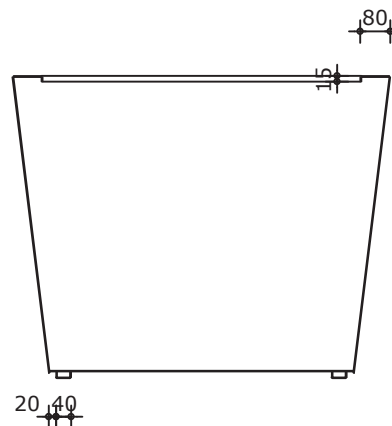

Verticale doorsnede

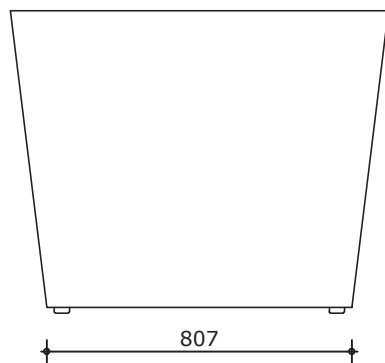

Vooraanzicht

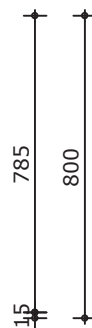

Inhoud : 0.51m3
Gewicht : 62kg
Afwerking : Nvt

Omschrijving : Cado CC1
Opdrachtgever : Adezz
Werknummer : Standaard
Plaats : Uden (NL)
Blad : 1/1

Get. : R. Langens
Schaal : 1:20
Datum : 01-04-2014
Wijz. :



Mandenmakerstraat 9, 5405 BJ Uden.
Postbus 607, 5400 AP Uden (NL).
t 0031 (0)413 - 24 6059.
e info@adezz.com, i www.adezz.com

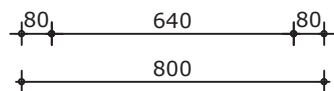
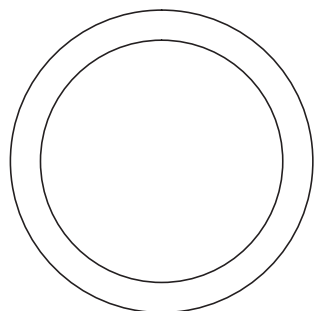

Bovenaanzicht

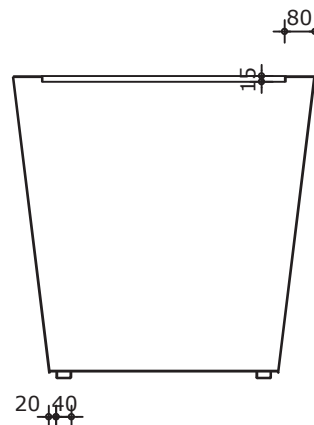

Verticale doorsnede

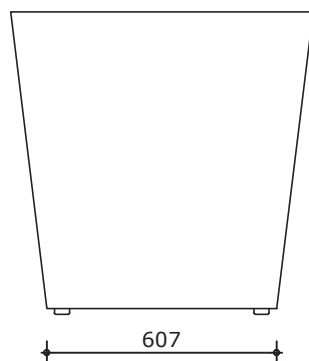

Vooraanzicht



Inhoud : 0.31m3
Gewicht : 47kg
Afwerking : Nvt

Omschrijving : Cado CC2
Opdrachtgever : Adezz
Werknnummer : Standaard
Plaats : Uden (NL)
Blad : 1/1

Get. : R. Langens
Schaal : 1:20
Datum : 01-04-2014
Wijz. :



Mandenmakerstraat 9, 5405 BJ Uden.
Postbus 607, 5400 AP Uden (NL).
t 0031 (0)413 - 24 6059.
e info@adezz.com, i www.adezz.com

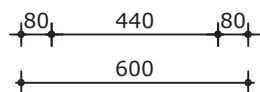
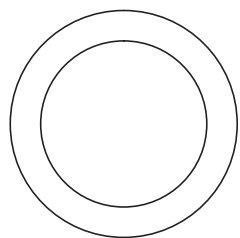

Bovenaanzicht

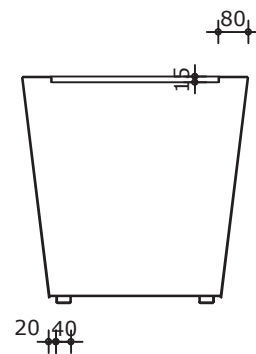

Verticale doorsnede

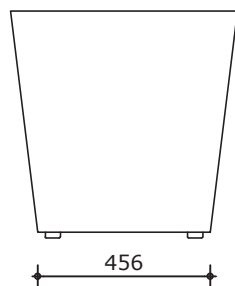

Vooraanzicht



Inhoud : 0.12m3
Gewicht : 28kg
Afwerking : Nvt

Omschrijving : Cado CC3
Opdrachtgever : Adezz
Werknnummer : Standaard
Plaats : Uden (NL)
Blad : 1/1

Get. : R. Langens
Schaal : 1:20
Datum : 01-04-2014
Wijz. :



Mandenmakerstraat 9, 5405 BJ Uden.
Postbus 607, 5400 AP Uden (NL).
t 0031 (0)413 - 24 6059.
e info@adezz.com, i www.adezz.com

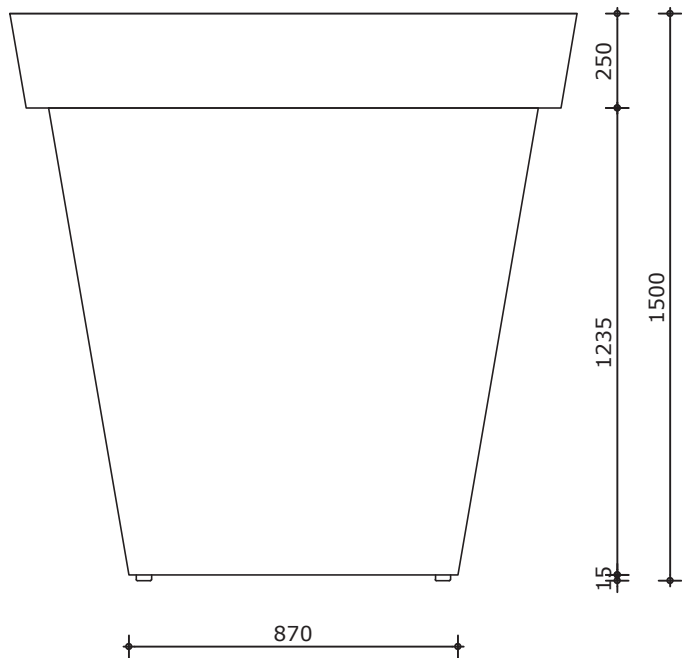

Voorraanzicht

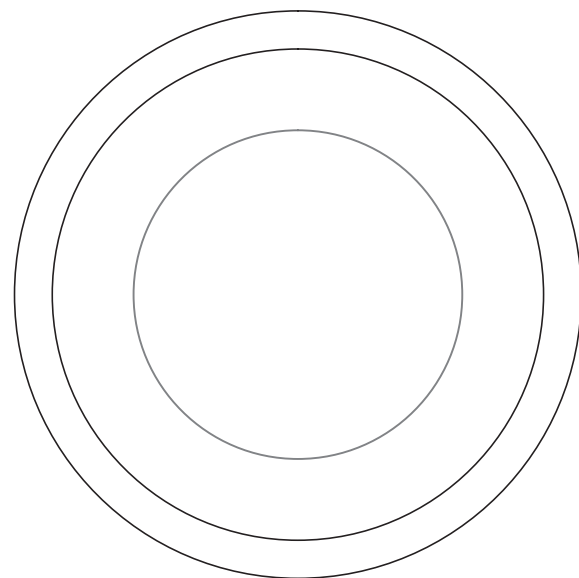

Bovenaanzicht

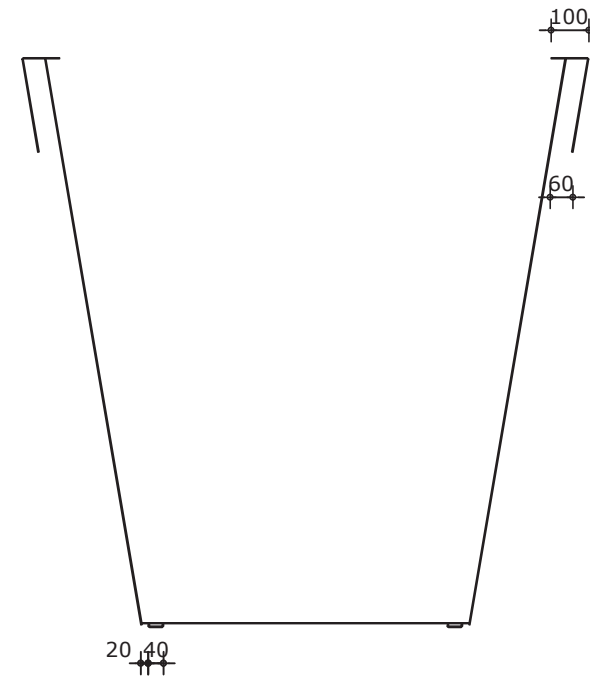

Doorsnede

Inhoud : m3
Gewicht : 145kg
Afwerking : Nvt

Omschrijving : Celso CS1
Opdrachtgever : Adezz
Werknummer : Standaard
Plaats : Uden (NL)
Blad : 1/1

Get. : R. Langens
Schaal : 1:20
Datum : 01-04-2014
Wijz. :



Mandenmakerstraat 9, 5405 BJ Uden.
Postbus 607, 5400 AP Uden (NL).
t 0031 (0)413 - 24 6059.
e info@adezz.com, i www.adezz.com

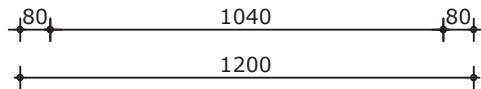
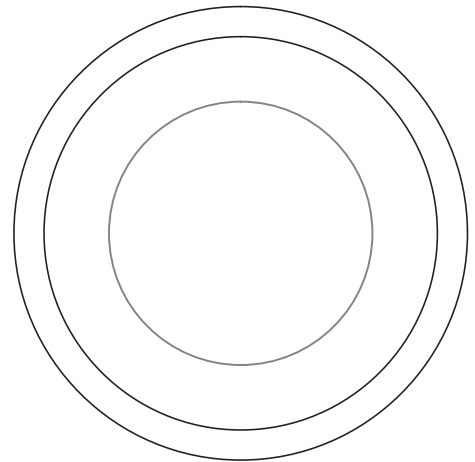

Bovenaanzicht

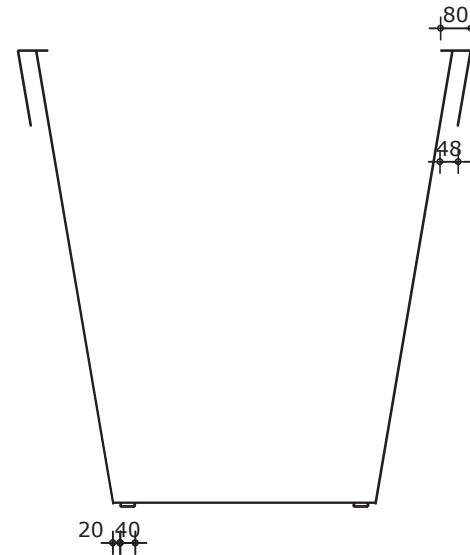

Doorsnede

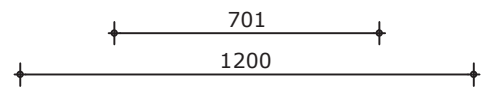
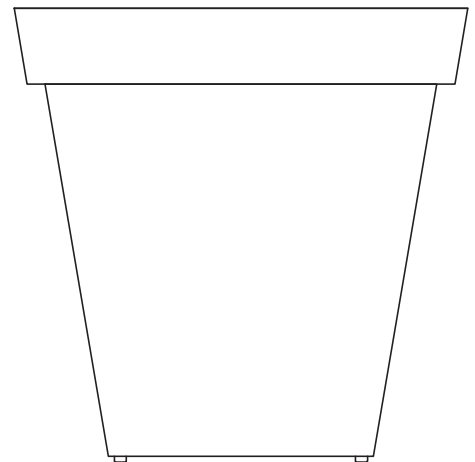

Vooraanzicht



Inhoud : m3
Gewicht : 90kg
Afwerking : Nvt

Omschrijving : Celso CS2
Opdrachtgever : Adezz
Werknummer : Standaard
Plaats : Uden (NL)
Blad : 1/1

Get. : R. Langens
Schaal : 1:20
Datum : 01-04-2014
Wijz. :



Mandenmakerstraat 9, 5405 BJ Uden.
Postbus 607, 5400 AP Uden (NL).
t 0031 (0)413 - 24 6059.
e info@adezz.com, i www.adezz.com

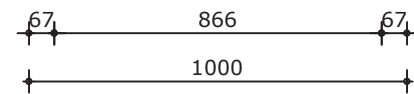
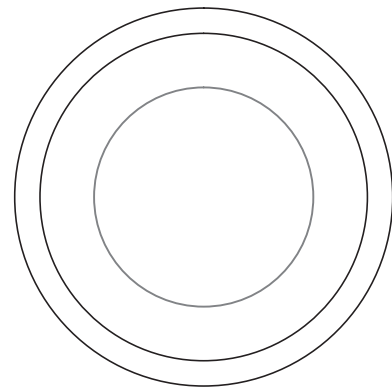

Bovenaanzicht

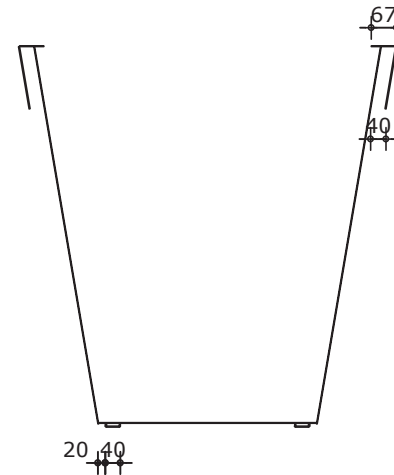

Doorsnede

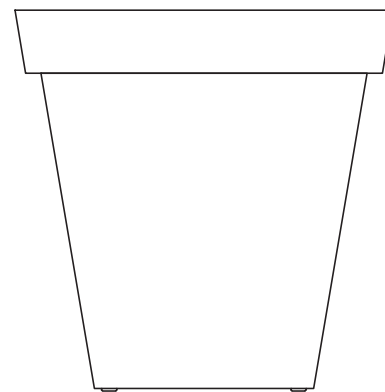

Vooraanzicht



Inhoud : m3
Gewicht : 59kg
Afwerking : Nvt

Omschrijving : Celso CS3
Opdrachtgever : Adezz
Werknummer : Standaard
Plaats : Uden (NL)
Blad : 1/1

Get. : R. Langens
Schaal : 1:20
Datum : 01-04-2014
Wijz. :



Mandenmakerstraat 9, 5405 BJ Uden.
Postbus 607, 5400 AP Uden (NL).
t 0031 (0)413 - 24 6059.
e info@adezz.com, i www.adezz.com

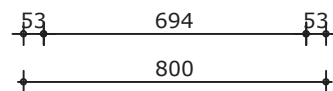
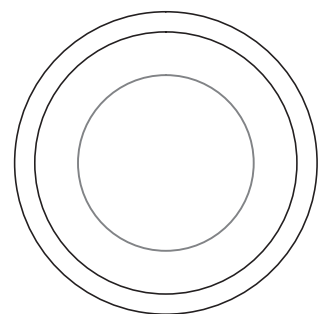

Bovenaanzicht

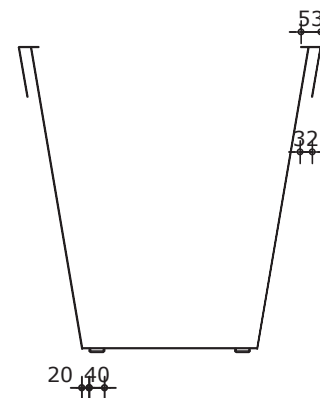

Doorsnede

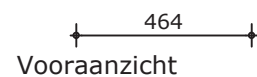
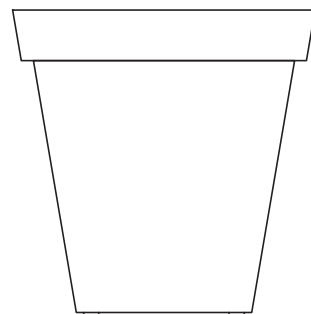

Vooraanzicht

Inhoud : m3
Gewicht : 25kg
Afwerking : Nvt

Omschrijving : Celso CS4
Opdrachtgever : Adezz
Werknummer : Standaard
Plaats : Uden (NL)
Blad : 1/1

Get. : R. Langens
Schaal : 1:20
Datum : 01-04-2014
Wijz. :



Mandenmakerstraat 9, 5405 BJ Uden.
Postbus 607, 5400 AP Uden (NL).
t 0031 (0)413 - 24 6059.
e info@adezz.com, i www.adezz.com

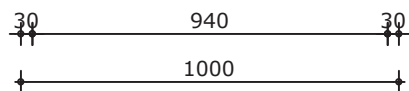
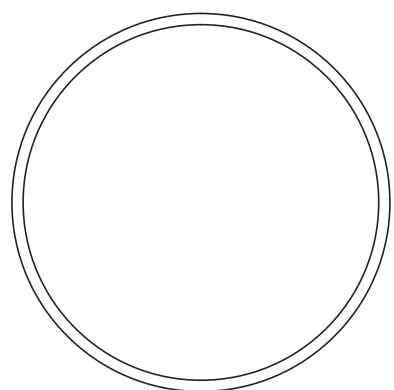

Bovenaanzicht

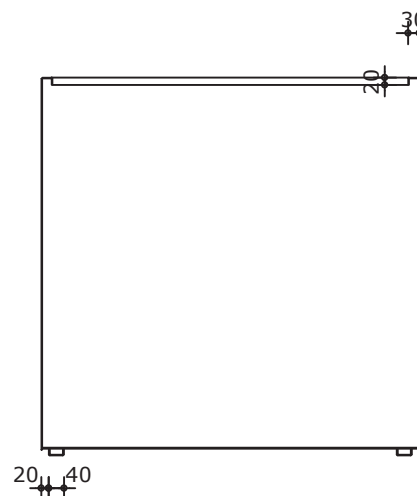

Verticale doorsnede

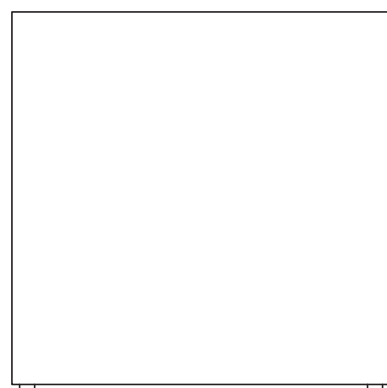

Vooraanzicht

Inhoud : 0.79m3
Gewicht : 69kg
Afwerking : Nvt

Omschrijving : Atlas CT1
Opdrachtgever : Adezz
Werknummer : Standaard
Plaats : Uden (NL)
Blad : 1/1

Get. : R. Langens
Schaal : 1:20
Datum : 01-04-2014
Wijz. :



Mandenmakerstraat 9, 5405 BJ Uden.
Postbus 607, 5400 AP Uden (NL).
t 0031 (0)413 - 24 6059.
e info@adezz.com, i www.adezz.com

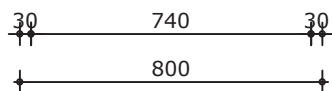
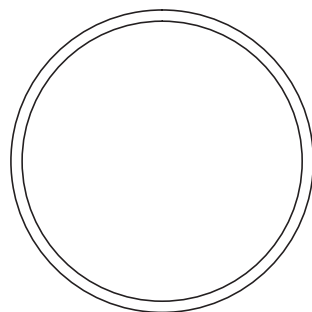

Bovenaanzicht

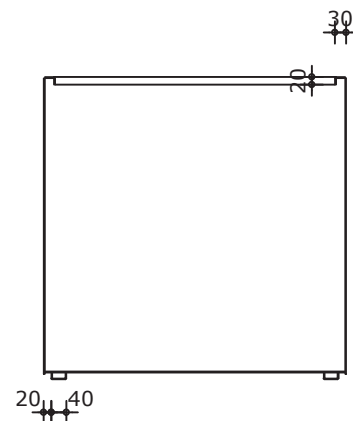

Verticale doorsnede

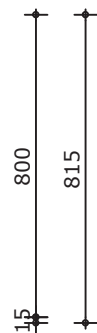
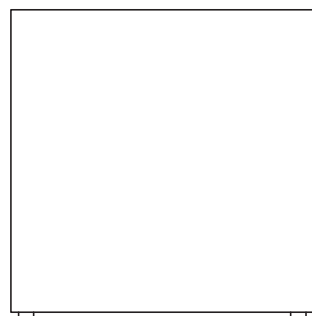

Vooraanzicht

Inhoud : 0.40m3
Gewicht : 45kg
Afwerking : Nvt

Omschrijving : Atlas CT2
Opdrachtgever : Adezz
Werknummer : Standaard
Plaats : Uden (NL)
Blad : 1/1

Get. : R. Langens
Schaal : 1:20
Datum : 01-04-2014
Wijz. :



Mandenmakerstraat 9, 5405 BJ Uden.
Postbus 607, 5400 AP Uden (NL).
t 0031 (0)413 - 24 6059.
e info@adezz.com, i www.adezz.com

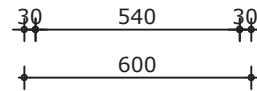
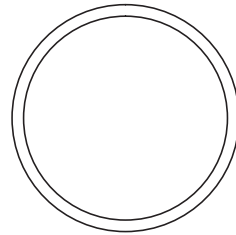

Bovenaanzicht

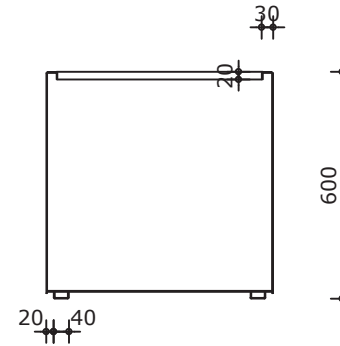

Verticale doorsnede

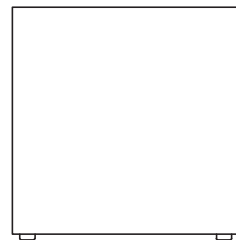

Vooraanzicht

Inhoud : 0.17m3
Gewicht : 26kg
Afwerking : Nvt

Omschrijving : Atlas CT3
Opdrachtgever : Adezz
Werknummer : Standaard
Plaats : Uden (NL)
Blad : 1/1

Get. : R. Langens
Schaal : 1:20
Datum : 01-04-2014
Wijz. :



Mandenmakerstraat 9, 5405 BJ Uden.
Postbus 607, 5400 AP Uden (NL).
t 0031 (0)413 - 24 6059.
e info@adezz.com, i www.adezz.com

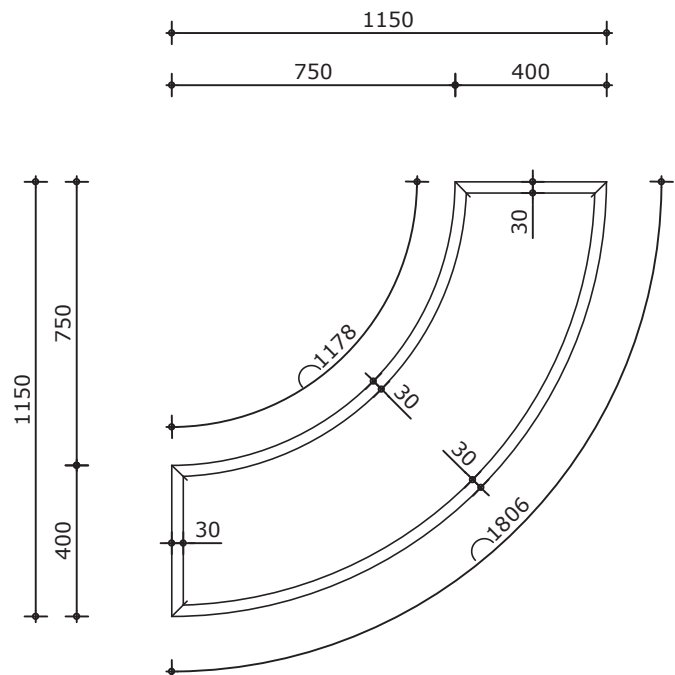

Bovenaanzicht

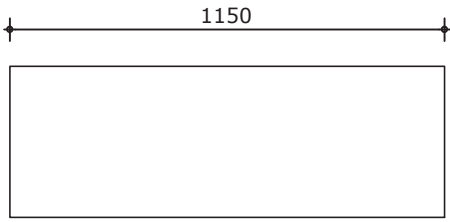

Vooraanzicht

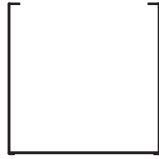

Verticale doorsnede

Inhoud : 0.24m3
 Gewicht : 60kg
 Afwerking : Nvt

| | |
|--------------------------|--------------------|
| Omschrijving : Carpa CR1 | Get. : R. Langens |
| Opdrachtgever : Adezz | Schaal : 1:20 |
| Werknummer : Standaard | Datum : 01-04-2014 |
| Plaats : Uden (NL) | Wijz. : |
| Blad : 1/1 | |



Mandenmakerstraat 9, 5405 BJ Uden.
 Postbus 607, 5400 AP Uden (NL).
 t 0031 (0)413 - 24 6059.
 e info@adezz.com, i www.adezz.com

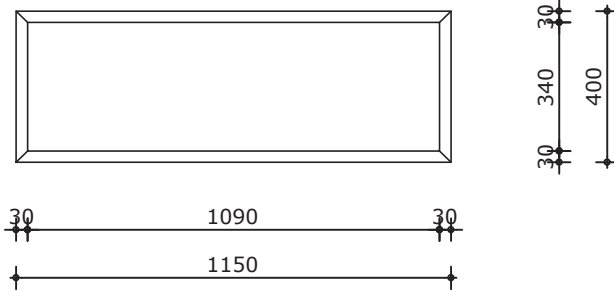

Bovenaanzicht

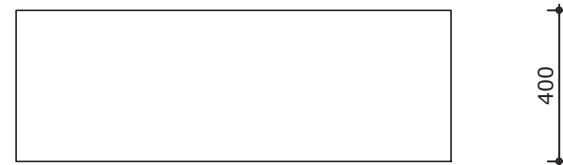

Vooraanzicht

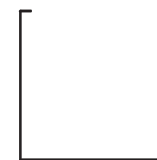

Verticale doorsnede

Inhoud : 0.18m3
 Gewicht : 45kg
 Afwerking : Nvt

Omschrijving : Carpa CR2
 Opdrachtgever : Adezz
 Werknummer : Standaard
 Plaats : Uden (NL)
 Blad : 1/1

Get. : R. Langens
 Schaal : 1:20
 Datum : 01-04-2014
 Wijz. :



Mandenmakerstraat 9, 5405 BJ Uden.
 Postbus 607, 5400 AP Uden (NL).
 t 0031 (0)413 - 24 6059.
 e info@adezz.com, i www.adezz.com

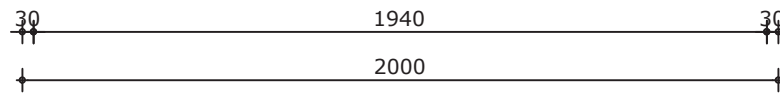
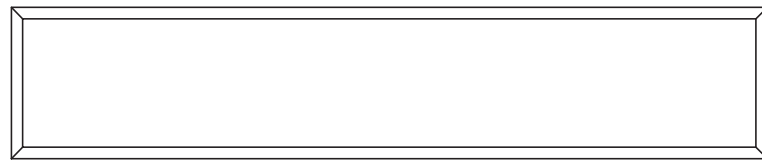

Bovenaanzicht



Vooraanzicht

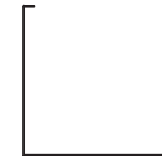
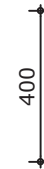

Verticale doorsnede

Inhoud : 0.32m3
Gewicht : 72kg
Afwerking : Nvt

Omschrijving : Carpa CR3
Opdrachtgever : Adezz
Werknummer : Standaard
Plaats : Uden (NL)
Blad : 1/1

Get. : R. Langens
Schaal : 1:20
Datum : 01-04-2014
Wijz. :



Mandenmakerstraat 9, 5405 BJ Uden.
Postbus 607, 5400 AP Uden (NL).
t 0031 (0)413 - 24 6059.
e info@adezz.com, i www.adezz.com

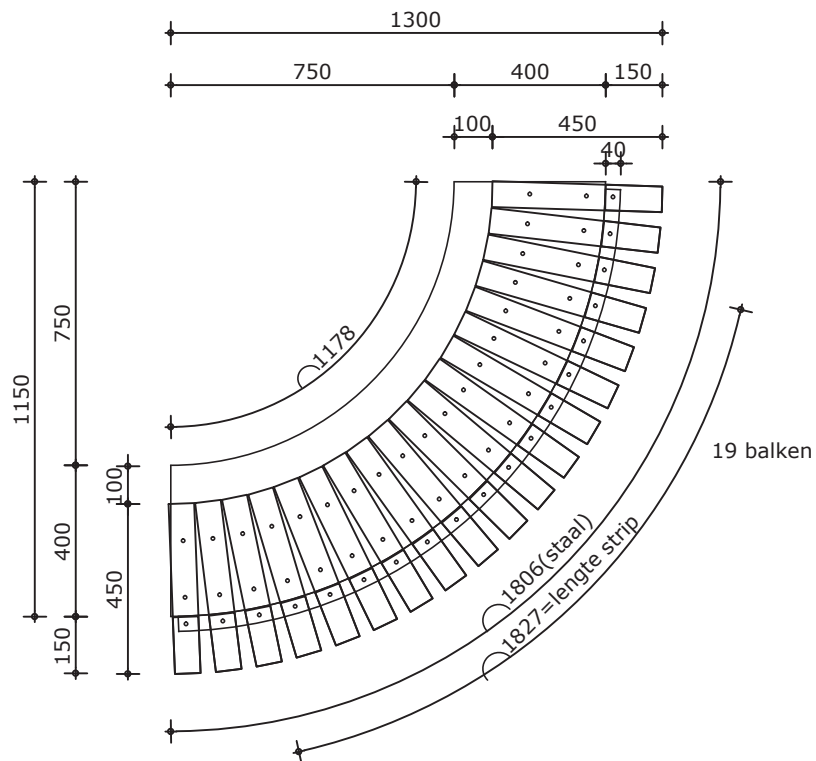

Bovenaanzicht

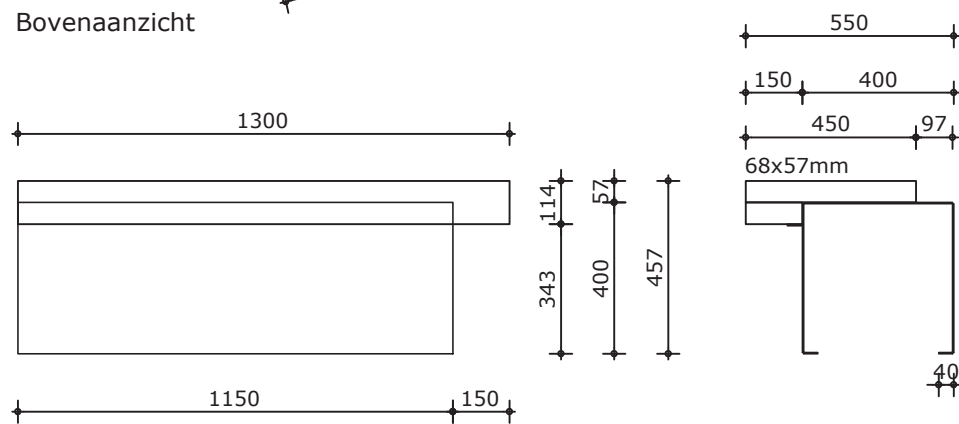

Vooraanzicht

Verticale doorsnede

Gewicht : 96kg
Afwerking : Nvt

Omschrijving : Carpa CRH1
Opdrachtgever : Adezz
Werknummer : Standaard
Plaats : Uden (NL)
Blad : 1/1

Get. : R. Langens
Schaal : 1:20
Datum : 01-04-2014
Wijz. :



Mandenmakerstraat 9, 5405 BJ Uden.
Postbus 607, 5400 AP Uden (NL).
t 0031 (0)413 - 24 6059.
e info@adezz.com, i www.adezz.com

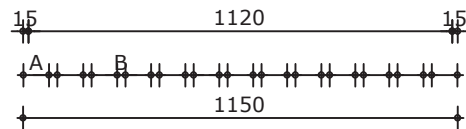
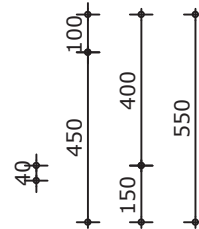

13xA A=68mm
12xB B=12mm

Bovenaanzicht

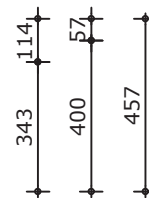
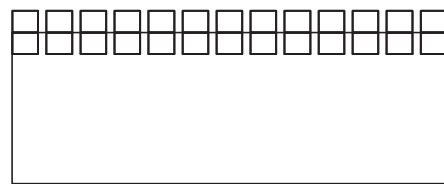

Voorraanzicht

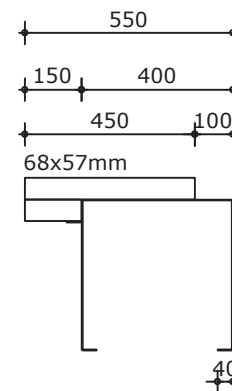

Verticale doorsnede

Gewicht : 93kg
Afwerking : Nvt

Omschrijving : Carpa CRH2
Opdrachtgever : Adezz
Werknummer : Standaard
Plaats : Uden (NL)
Blad : 1/1

Get. : R. Langens
Schaal : 1:20
Datum : 01-04-2014
Wijz. :



Mandenmakerstraat 9, 5405 BJ Uden.
Postbus 607, 5400 AP Uden (NL).
t 0031 (0)413 - 24 6059.
e info@adezz.com, i www.adezz.com

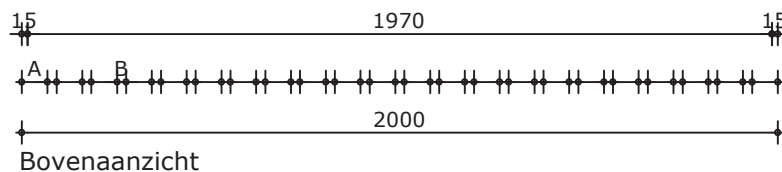

Bovenaanzicht

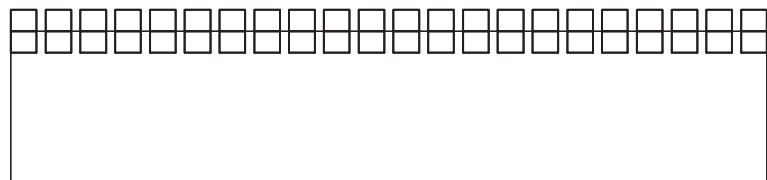

Vooraanzicht

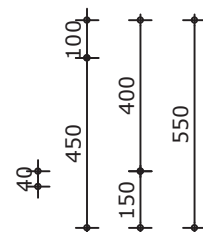

22xA A=68mm
21xB B=24mm

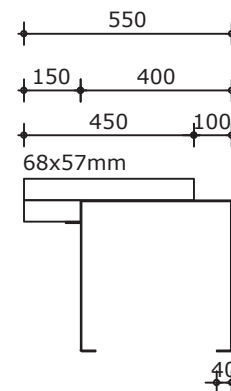

Verticale doorsnede

Gewicht : 122kg
Afwerking : Nvt

Omschrijving : Carpa CRH3
Opdrachtgever : Adezz
Werknummer : Standaard
Plaats : Uden (NL)
Blad : 1/1

Get. : R. Langens
Schaal : 1:20
Datum : 01-04-2014
Wijz. :



Mandenmakerstraat 9, 5405 BJ Uden.
Postbus 607, 5400 AP Uden (NL).
t 0031 (0)413 - 24 6059.
e info@adezz.com, i www.adezz.com

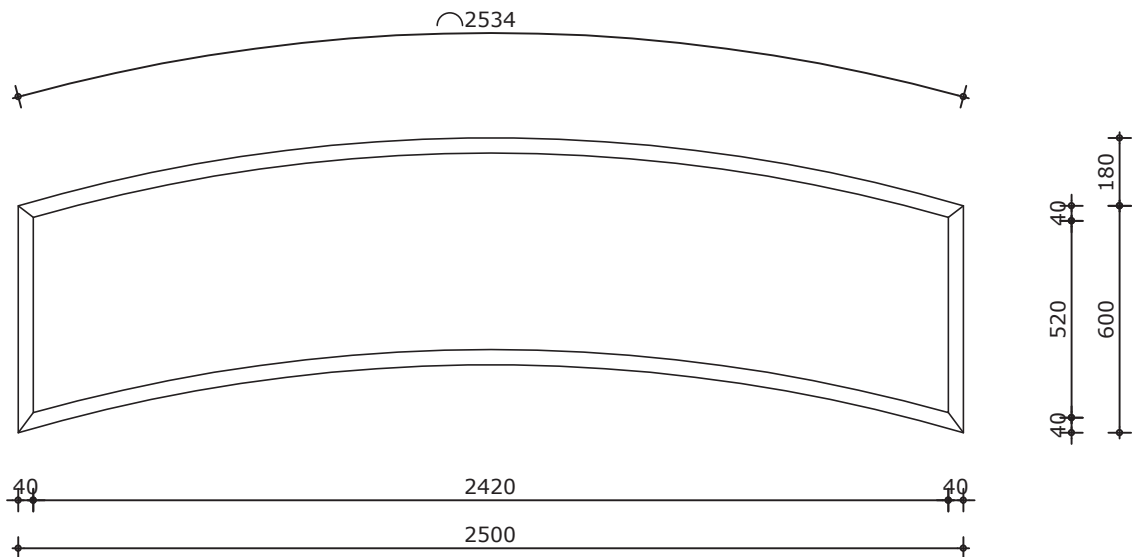

Bovenaanzicht

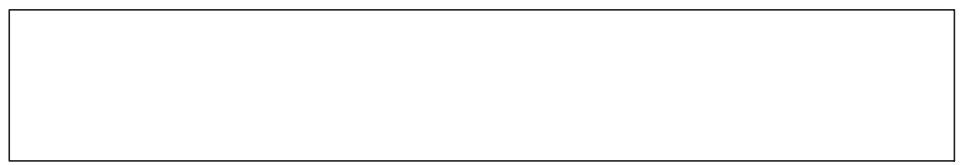

Vooraanzicht



Verticale doorsnede

Inhoud : 0.68m3
 Gewicht : 107kg
 Afwerking : Nvt

| | |
|---|---|
| Omschrijving : Carva CV1 Opdrachtgever : Adezz Werknummer : Standaard Plaats : Uden (NL) Blad : 1/1 | Get. : R. Langens Schaal : 1:20 Datum : 01-04-2014 Wijz. : |
|---|---|



Mandenmakerstraat 9, 5405 BJ Uden.
 Postbus 607, 5400 AP Uden (NL).
 t 0031 (0)413 - 24 6059.
 e info@adezz.com, i www.adezz.com

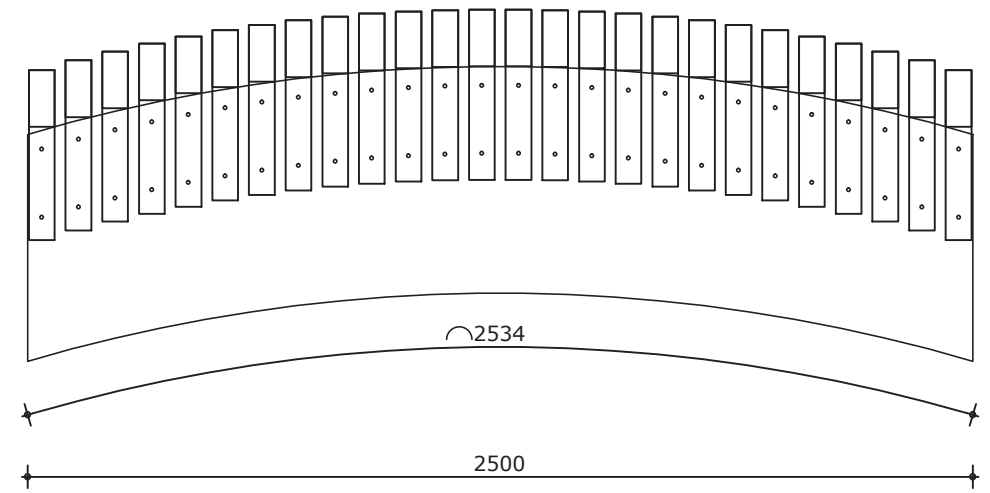

Bovenaanzicht

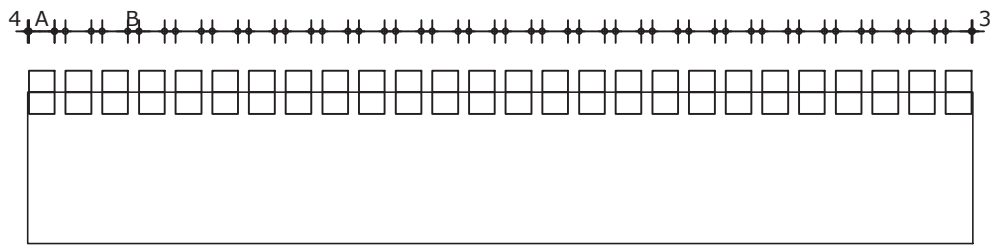

Vooraanzicht

26xA A=68mm
25xB B=29mm

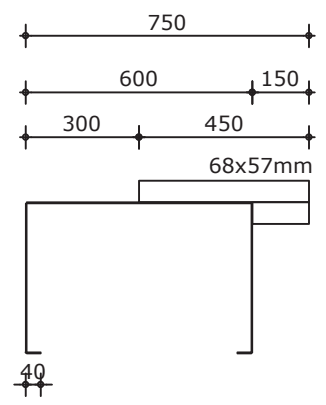

Verticale doorsnede

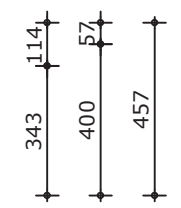

Gewicht : 242kg
Afwerking : Nvt

| | |
|---------------------------|--------------------|
| Omschrijving : Carva CVH1 | Get. : R. Langens |
| Opdrachtgever : Adezz | Schaal : 1:20 |
| Werknummer : Standaard | Datum : 01-04-2014 |
| Plaats : Uden (NL) | Wijz. : |
| Blad : 1/1 | |



Mandenmakerstraat 9, 5405 BJ Uden.
Postbus 607, 5400 AP Uden (NL).
t 0031 (0)413 - 24 6059.
e info@adezz.com, i www.adezz.com