

Information produit : Bacs en aluminium

L'aluminium est un matériau léger, robuste et résistant à la corrosion. Le chant supérieur des bacs est plié deux fois ce qui procure aux bacs une belle finition et une apparence de robustesse. En standard, les bacs en aluminium sont fabriqués en tôle d'épaisseur 3mm. Il est également possible de les fabriquer avec des épaisseurs de 4 ou 5mm. Chaque bac est fait avec des pieds de 15mm de haut pour les surélever légèrement du solde.

Une fois construit, on applique sur le bac un primaire d'adhérence et une peinture epoxy résistante à la rayure.

Avantages :

- Robustesse / durabilité
- Légèreté
- Matériau résistant à la corrosion
- Peinture résistante à la rayure
- Garantie 5 ans

En option :

- Choix de la couleur parmi la totalité de la palette RAL
- Pieds de dimensions 100x100x90(H) mm (seulement pour modèles FLORIDA)
- Application d'une couche d'étanchéité dans le bac possible
- Montage de roulettes possibles (seulement pour modèles FLORIDA)
- Produit d'entretien disponible



Il est possible de fabriquer les bacs sur-mesure et dans une teinte au choix. Les bacs aluminium sont non seulement adaptés à un usage extérieur mais également compatible avec une utilisation en intérieur.

Modèles disponibles : Cairo, Florida et Sydney.

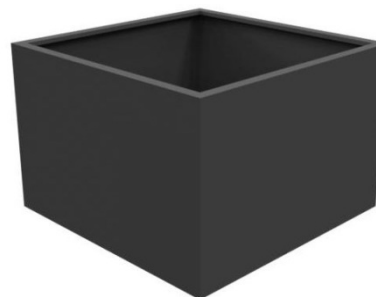

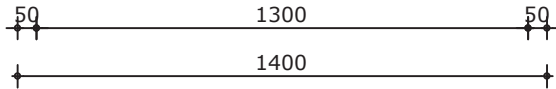
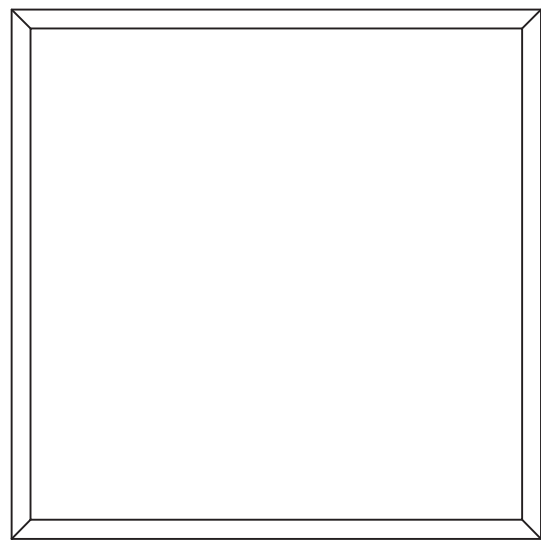

Bovenaanzicht

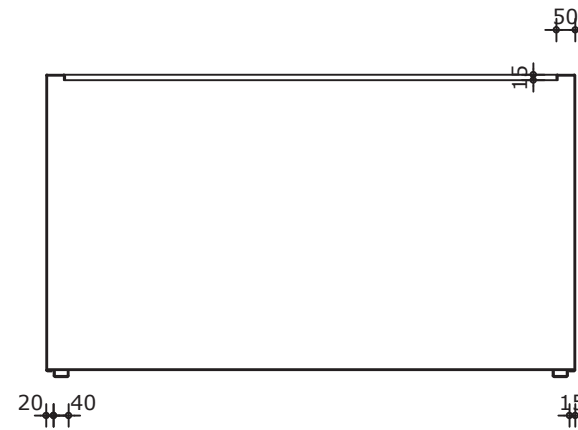

Verticale doorsnede



Vooraanzicht

Inhoud : 1.57m3
Gewicht : 58kg
Afwerking : RAL7021

Omschrijving : Florida AF1
Opdrachtgever : Adezz
Werknummer : Standaard
Plaats : Uden (NL)
Blad : 1/1

Get. : R. Langens
Schaal : 1:20
Datum : 01-04-2014
Wijz. :



Mandenmakerstraat 9, 5405 BJ Uden.
Postbus 607, 5400 AP Uden (NL).
t 0031 (0)413 - 24 6059.
e info@adezz.com, i www.adezz.com

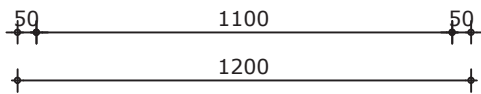
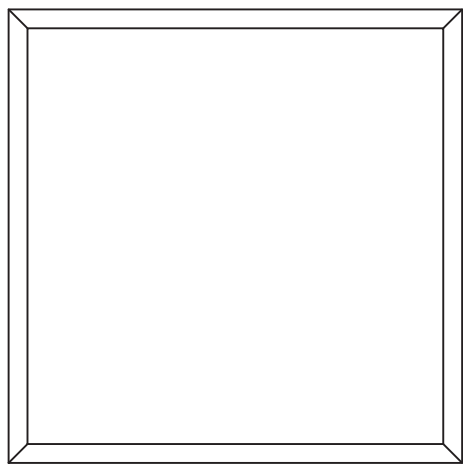

Bovenaanzicht

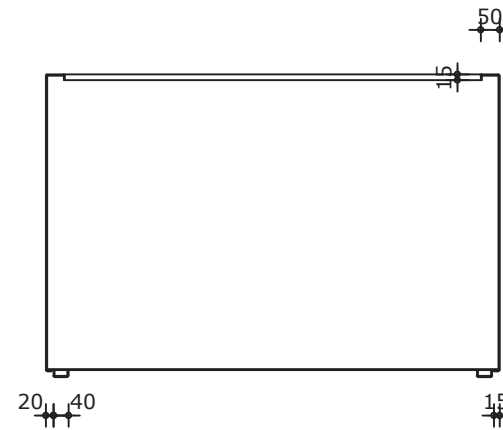

Verticale doorsnede

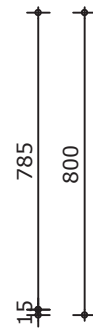

Vooraanzicht

Inhoud : 1.15m3
Gewicht : 47kg
Afwerking : RAL7021

Omschrijving : Florida AF2
Opdrachtgever : Adezz
Werknummer : Standaard
Plaats : Uden (NL)
Blad : 1/1

Get. : R. Langens
Schaal : 1:20
Datum : 01-04-2014
Wijz. :



Mandenmakerstraat 9, 5405 BJ Uden.
Postbus 607, 5400 AP Uden (NL).
t 0031 (0)413 - 24 6059.
e info@adezz.com, i www.adezz.com

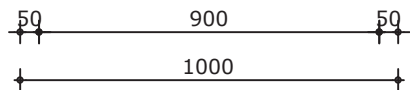
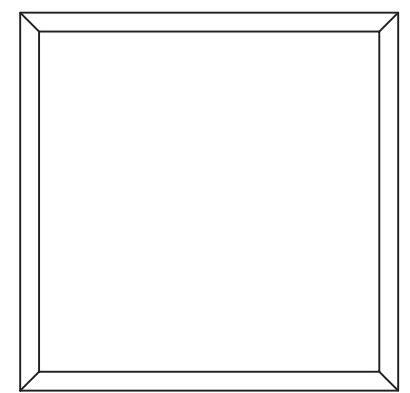

Bovenaanzicht

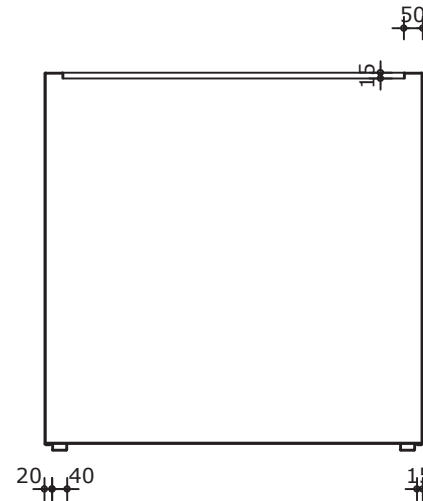

Verticale doorsnede

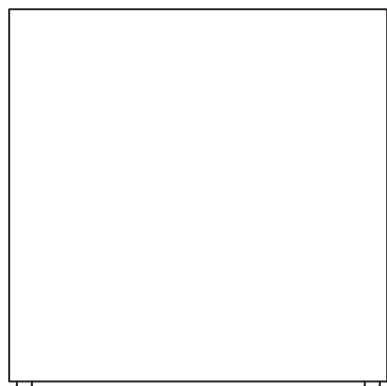

Vooraanzicht

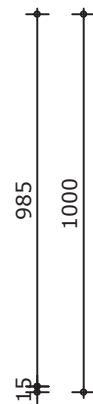

Inhoud : 1.00m3
Gewicht : 45kg
Afwerking : RAL7021

Omschrijving : Florida AF3
Opdrachtgever : Adezz
Werknummer : Standaard
Plaats : Uden (NL)
Blad : 1/1

Get. : R. Langens
Schaal : 1:20
Datum : 01-04-2014
Wijz. :



Mandenmakerstraat 9, 5405 BJ Uden.
Postbus 607, 5400 AP Uden (NL).
t 0031 (0)413 - 24 6059.
e info@adezz.com, i www.adezz.com

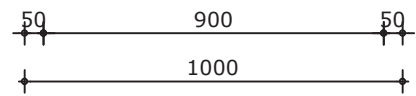
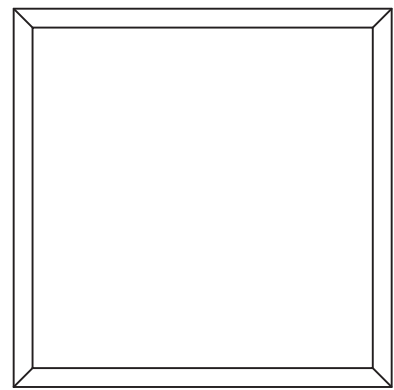

Bovenaanzicht

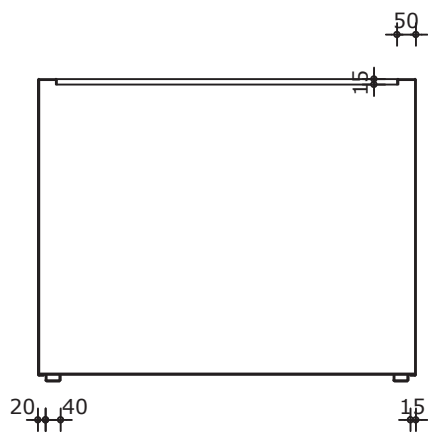

Verticale doorsnede

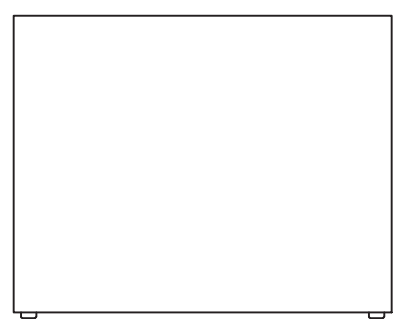

Vooraanzicht

Inhoud : 0.80m3
Gewicht : 38kg
Afwerking : RAL7021

Omschrijving : Florida AF4	Get. : R. Langens
Opdrachtgever : Adezz	Schaal : 1:20
Werknummer : Standaard	Datum : 01-04-2014
Plaats : Uden (NL)	Wijz. :
Blad : 1/1	



Mandenmakerstraat 9, 5405 BJ Uden.
Postbus 607, 5400 AP Uden (NL).
t 0031 (0)413 - 24 6059.
e info@adezz.com, i www.adezz.com

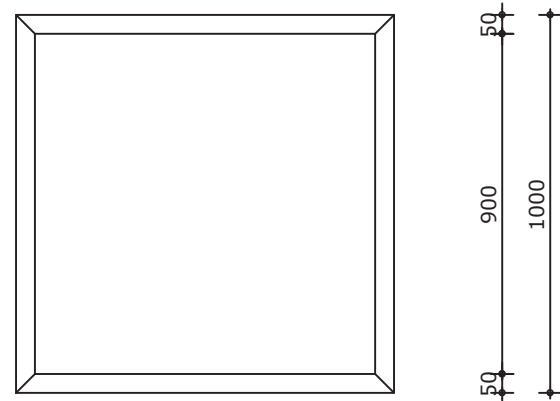

50 900 50
1000
Bovenaanzicht

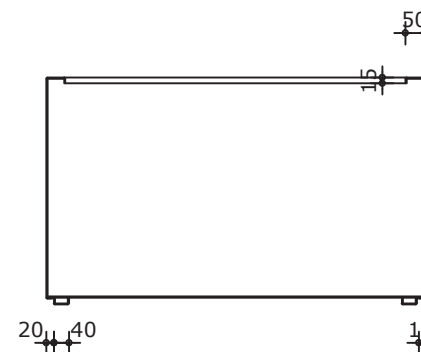

Verticale doorsnede

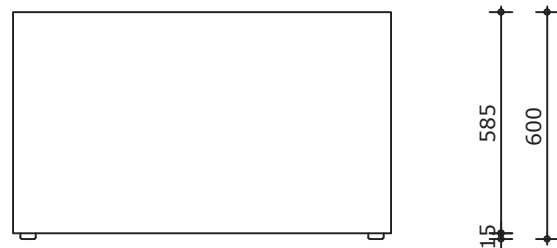

Vooraanzicht

Inhoud : 0.60m3
Gewicht : 30kg
Afwerking : RAL7021

Omschrijving : Florida AF4.1
Opdrachtgever : Adezz
Werknnummer : Standaard
Plaats : Uden (NL)
Blad : 1/1

Get. : R. Langens
Schaal : 1:20
Datum : 01-04-2014
Wijz. :



Mandenmakerstraat 9, 5405 BJ Uden.
Postbus 607, 5400 AP Uden (NL).
t 0031 (0)413 - 24 6059.
e info@adezz.com, i www.adezz.com

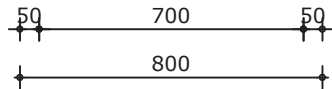
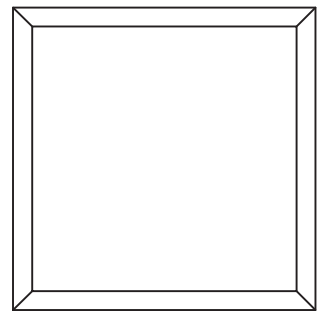

Bovenaanzicht

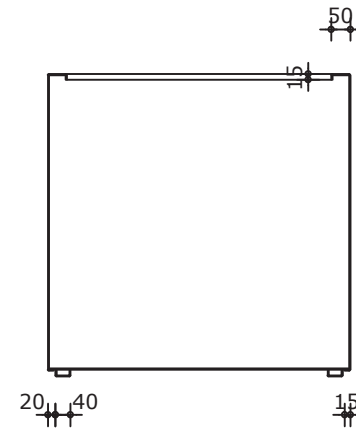

Verticale doorsnede

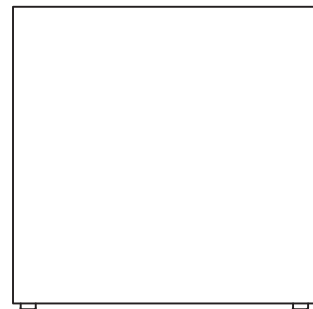

Vooraanzicht



Inhoud : 0.51m3
Gewicht : 29kg
Afwerking : RAL7021

Omschrijving : Florida AF5
Opdrachtgever : Adezz
Werknnummer : Standaard
Plaats : Uden (NL)
Blad : 1/1

Get. : R. Langens
Schaal : 1:20
Datum : 01-04-2014
Wijz. :



Mandenmakerstraat 9, 5405 BJ Uden.
Postbus 607, 5400 AP Uden (NL).
t 0031 (0)413 - 24 6059.
e info@adezz.com, i www.adezz.com

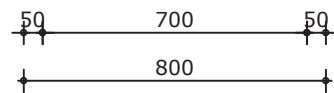
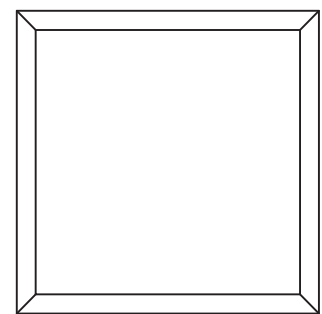

Bovenaanzicht

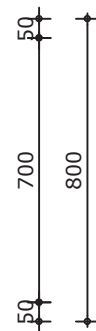

Vooraanzicht

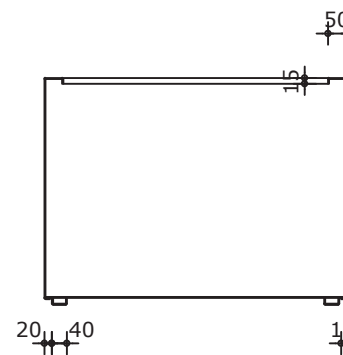

Verticale doorsnede

Inhoud : 0.38m3
Gewicht : 23kg
Afwerking : RAL7021

Omschrijving : Florida AF5.1
Opdrachtgever : Adezz
Werknummer : Standaard
Plaats : Uden (NL)
Blad : 1/1

Get. : R. Langens
Schaal : 1:20
Datum : 01-04-2014
Wijz. :



Mandenmakerstraat 9, 5405 BJ Uden.
Postbus 607, 5400 AP Uden (NL).
t 0031 (0)413 - 24 6059.
e info@adezz.com, i www.adezz.com

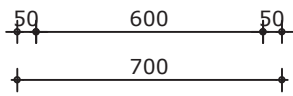
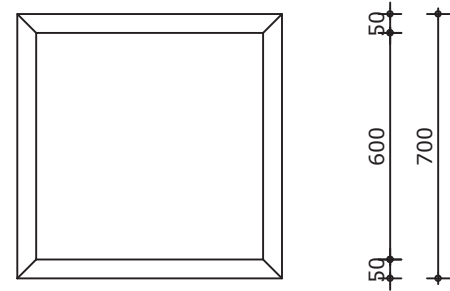

Bovenaanzicht

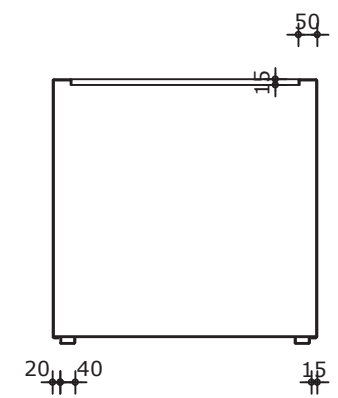

Verticale doorsnede

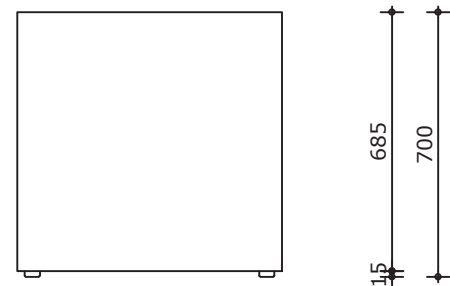

Vooraanzicht

Inhoud : 0.34m3
 Gewicht : 22kg
 Afwerking : RAL7021

Omschrijving : Florida AF6	Get. : R. Langens
Opdrachtgever : Adezz	Schaal : 1:20
Werknummer : Standaard	Datum : 01-04-2014
Plaats : Uden (NL)	Wijz. :
Blad : 1/1	



Mandenmakerstraat 9, 5405 BJ Uden.
 Postbus 607, 5400 AP Uden (NL).
 t 0031 (0)413 - 24 6059.
 e info@adezz.com, i www.adezz.com

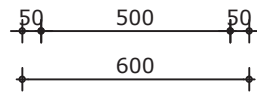
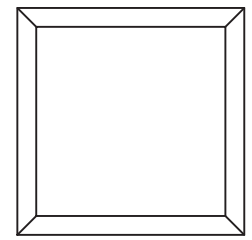

Bovenaanzicht

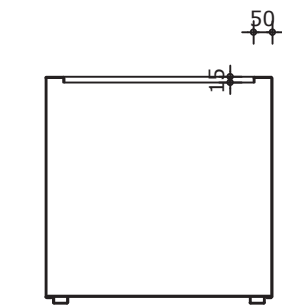

Verticale doorsnede

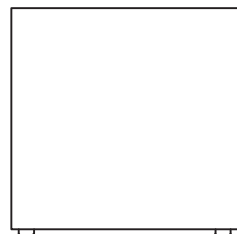

Vooraanzicht

Inhoud : 0.22m3
Gewicht : 16kg
Afwerking : RAL7021

Omschrijving : Florida AF7
Opdrachtgever : Adezz
Werknummer : Standaard
Plaats : Uden (NL)
Blad : 1/1

Get. : R. Langens
Schaal : 1:20
Datum : 01-04-2014
Wijz. :



Mandenmakerstraat 9, 5405 BJ Uden.
Postbus 607, 5400 AP Uden (NL).
t 0031 (0)413 - 24 6059.
e info@adezz.com, i www.adezz.com

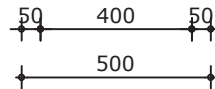
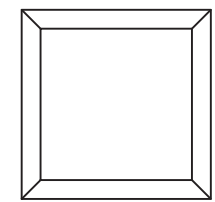

Bovenaanzicht

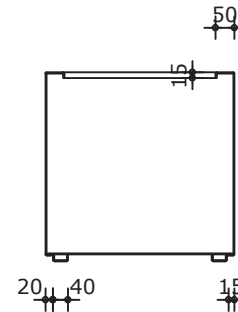
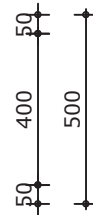

Verticale doorsnede

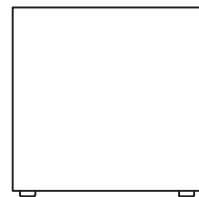

Vooraanzicht



Inhoud : 0.13m3
Gewicht : 12kg
Afwerking : RAL7021

Omschrijving : Florida AF8
Opdrachtgever : Adezz
Werknummer : Standaard
Plaats : Uden (NL)
Blad : 1/1

Get. : R. Langens
Schaal : 1:20
Datum : 01-04-2014
Wijz. :



Mandenmakerstraat 9, 5405 BJ Uden.
Postbus 607, 5400 AP Uden (NL).
t 0031 (0)413 - 24 6059.
e info@adezz.com, i www.adezz.com

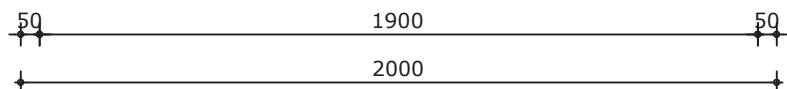
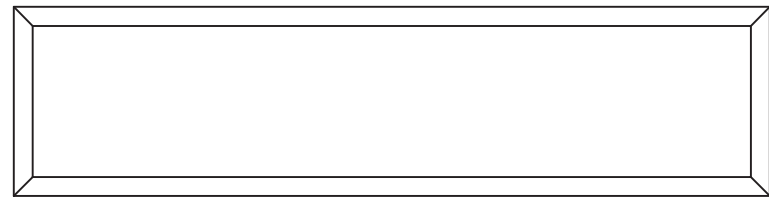

Bovenaanzicht

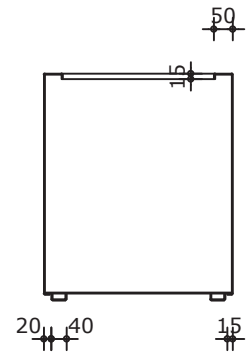

Verticale doorsnede

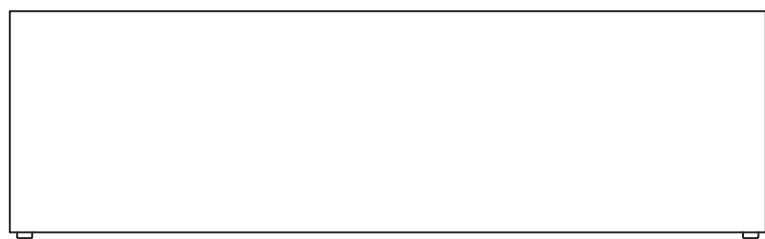

Vooraanzicht

Inhoud : 0.60m3
Gewicht : 37kg
Afwerking : RAL7021

Omschrijving : Florida AF9 Opdrachtgever : Adezz Werknummer : Standaard Plaats : Uden (NL) Blad : 1/1	Get. : R. Langens Schaal : 1:20 Datum : 01-04-2014 Wijz. :
---	---



Mandenmakerstraat 9, 5405 BJ Uden.
Postbus 607, 5400 AP Uden (NL).
t 0031 (0)413 - 24 6059.
e info@adezz.com, i www.adezz.com

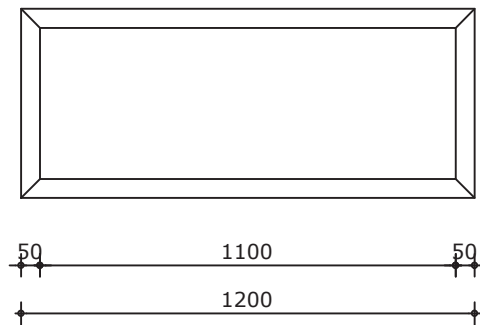

Bovenaanzicht

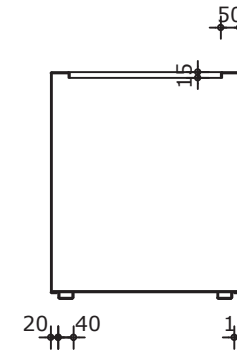
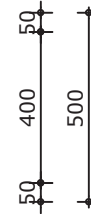

Verticale doorsnede

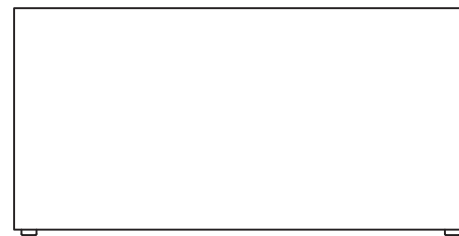

Vooraanzicht

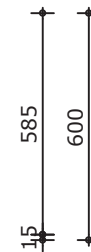

Inhoud : 0.45m3
 Gewicht : 29kg
 Afwerking : RAL7021

Omschrijving : Florida AF10
 Opdrachtgever : Adezz
 Werknummer : Standaard
 Plaats : Uden (NL)
 Blad : 1/1

Get. : R. Langens
 Schaal : 1:20
 Datum : 01-04-2014
 Wijz. :



Mandenmakerstraat 9, 5405 BJ Uden.
 Postbus 607, 5400 AP Uden (NL).
 t 0031 (0)413 - 24 6059.
 e info@adezz.com, i www.adezz.com

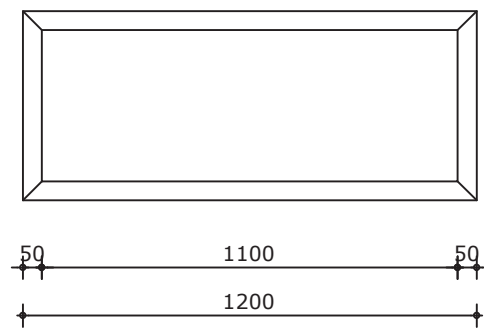

Bovenaanzicht

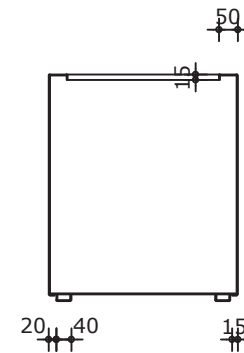

Verticale doorsnede

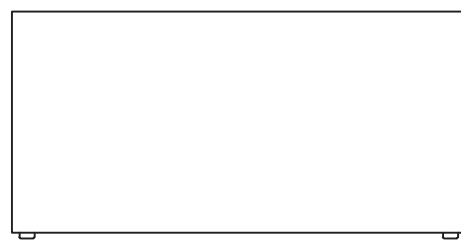

Vooraanzicht



Inhoud : 0.36m3
Gewicht : 24kg
Afwerking : RAL7021

Omschrijving : Florida AF11
Opdrachtgever : Adezz
Werknummer : Standaard
Plaats : Uden (NL)
Blad : 1/1

Get. : R. Langens
Schaal : 1:20
Datum : 01-04-2014
Wijz. :



Mandenmakerstraat 9, 5405 BJ Uden.
Postbus 607, 5400 AP Uden (NL).
t 0031 (0)413 - 24 6059.
e info@adezz.com, i www.adezz.com

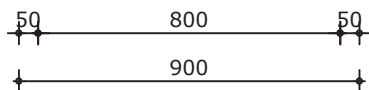
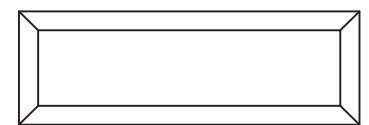

Bovenaanzicht

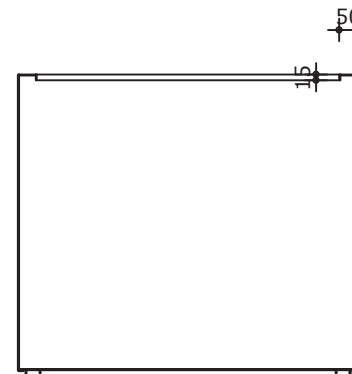

Verticale doorsnede

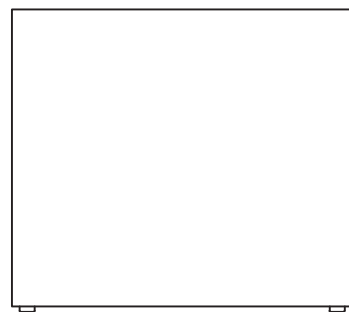

Vooraanzicht

Inhoud : 0.22m3
Gewicht : 20kg
Afwerking : RAL7021

Omschrijving : Florida AF12
Opdrachtgever : Adezz
Werknnummer : Standaard
Plaats : Uden (NL)
Blad : 1/1

Get. : R. Langens
Schaal : 1:20
Datum : 01-04-2014
Wijz. :



Mandenmakerstraat 9, 5405 BJ Uden.
Postbus 607, 5400 AP Uden (NL).
t 0031 (0)413 - 24 6059.
e info@adezz.com, i www.adezz.com

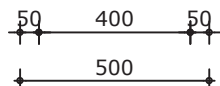
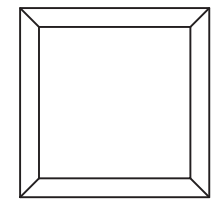

Bovenaanzicht

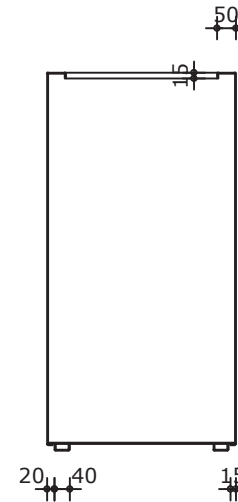
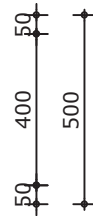

Verticale doorsnede

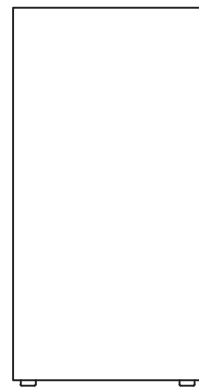

Vooraanzicht



Inhoud : 0.25m3
Gewicht : 20kg
Afwerking : RAL7021

Omschrijving : Florida AF13
Opdrachtgever : Adezz
Werknummer : Standaard
Plaats : Uden (NL)
Blad : 1/1

Get. : R. Langens
Schaal : 1:20
Datum : 01-04-2014
Wijz. :



Mandenmakerstraat 9, 5405 BJ Uden.
Postbus 607, 5400 AP Uden (NL).
t 0031 (0)413 - 24 6059.
e info@adezz.com, i www.adezz.com

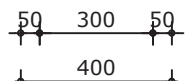
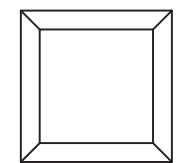

Bovenaanzicht

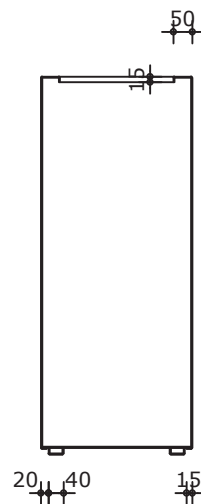

Verticale doorsnede

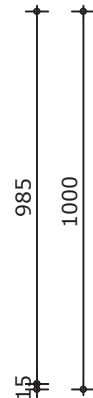
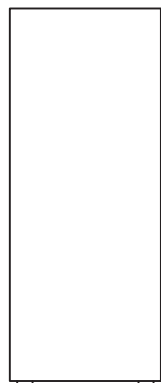

Vooraanzicht

Inhoud : 0.16m3
Gewicht : 16kg
Afwerking : RAL7021

Omschrijving : Florida AF14
Opdrachtgever : Adezz
Werknnummer : Standaard
Plaats : Uden (NL)
Blad : 1/1

Get. : R. Langens
Schaal : 1:20
Datum : 01-04-2014
Wijz. :



Mandenmakerstraat 9, 5405 BJ Uden.
Postbus 607, 5400 AP Uden (NL).
t 0031 (0)413 - 24 6059.
e info@adezz.com, i www.adezz.com

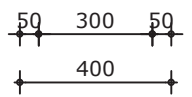
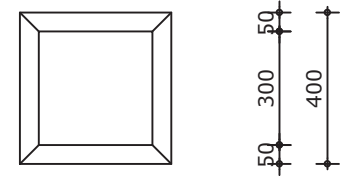

Bovenaanzicht

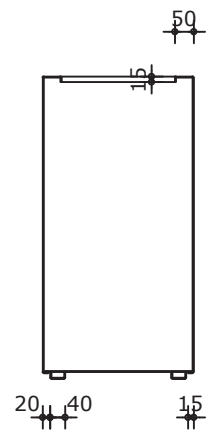

Verticale doorsnede

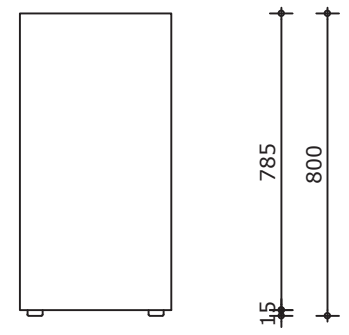

Vooraanzicht

Inhoud : 0.13m3
 Gewicht : 13kg
 Afwerking : RAL7021

Omschrijving : Florida AF15	Get. : R. Langens
Opdrachtgever : Adezz	Schaal : 1:20
Werknummer : Standaard	Datum : 01-04-2014
Plaats : Uden (NL)	Wijz. :
Blad : 1/1	



Mandenmakerstraat 9, 5405 BJ Uden.
 Postbus 607, 5400 AP Uden (NL).
 t 0031 (0)413 - 24 6059.
 e info@adezz.com, i www.adezz.com

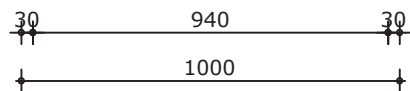
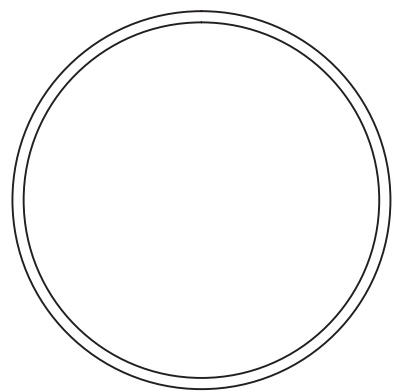

Bovenaanzicht

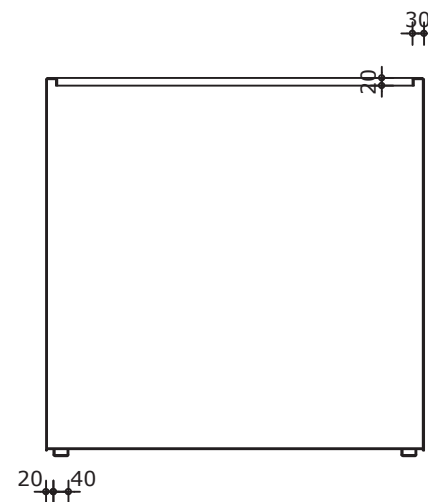

Verticale doorsnede

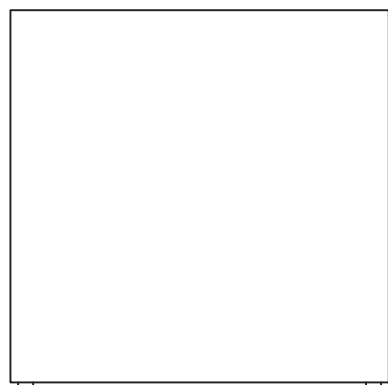

Vooraanzicht

Inhoud : 0.79m3
Gewicht : 36kg
Afwerking : RAL7021

Omschrijving : Sydney AM1
Opdrachtgever : Adezz
Werknnummer : Standaard
Plaats : Uden (NL)
Blad : 1/1

Get. : R. Langens
Schaal : 1:20
Datum : 01-04-2014
Wijz. :



Mandenmakerstraat 9, 5405 BJ Uden.
Postbus 607, 5400 AP Uden (NL).
t 0031 (0)413 - 24 6059.
e info@adezz.com, i www.adezz.com

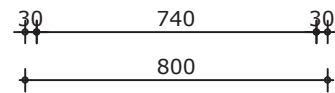
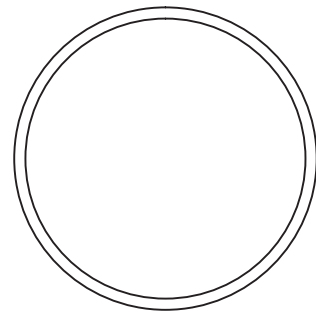

Bovenaanzicht

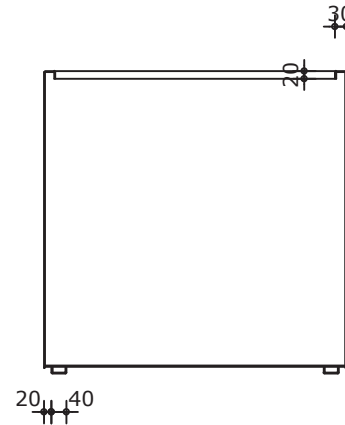

Verticale doorsnede

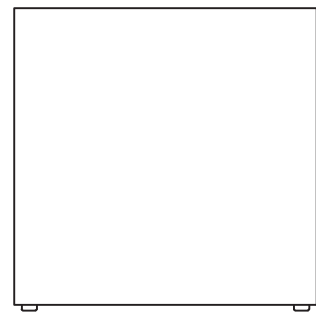

Vooraanzicht

Inhoud : 0.40m3
Gewicht : 24kg
Afwerking : RAL7021

Omschrijving : Sydney AM2
Opdrachtgever : Adezz
Werknummer : Standaard
Plaats : Uden (NL)
Blad : 1/1

Get. : R. Langens
Schaal : 1:20
Datum : 01-04-2014
Wijz. :



Mandenmakerstraat 9, 5405 BJ Uden.
Postbus 607, 5400 AP Uden (NL).
t 0031 (0)413 - 24 6059.
e info@adezz.com, i www.adezz.com

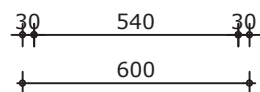
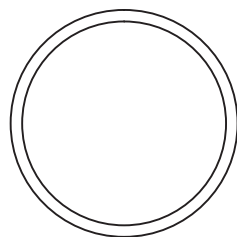

Bovenaanzicht

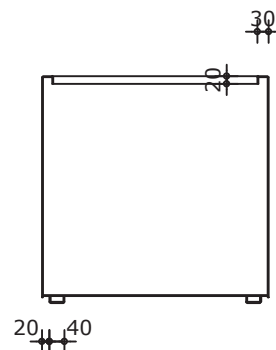

Verticale doorsnede

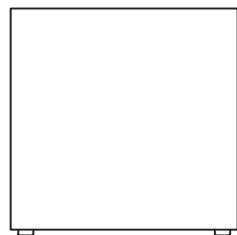

Vooraanzicht

Inhoud : 0.17m3
Gewicht : 13kg
Afwerking : RAL7021

Omschrijving : Sydney AM3
Opdrachtgever : Adezz
Werknummer : Standaard
Plaats : Uden (NL)
Blad : 1/1

Get. : R. Langens
Schaal : 1:20
Datum : 01-04-2014
Wijz. :



Mandenmakerstraat 9, 5405 BJ Uden.
Postbus 607, 5400 AP Uden (NL).
t 0031 (0)413 - 24 6059.
e info@adezz.com, i www.adezz.com

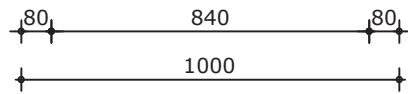
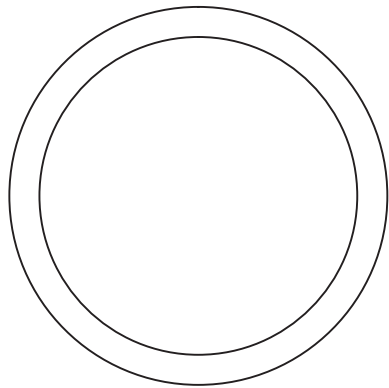

Bovenaanzicht

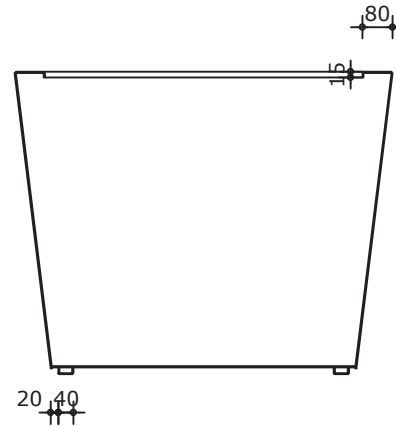

Verticale doorsnede

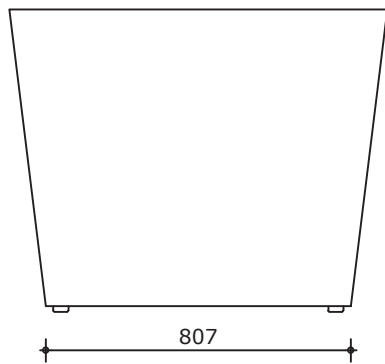

Vooraanzicht

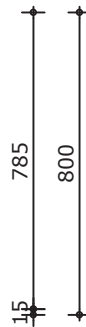

Inhoud : 0.51m3
Gewicht : 31kg
Afwerking : RAL7021

Omschrijving : Cairo AC1
Opdrachtgever : Adezz
Werknummer : Standaard
Plaats : Uden (NL)
Blad : 1/1

Get. : R. Langens
Schaal : 1:20
Datum : 01-04-2014
Wijz. :



Mandenmakerstraat 9, 5405 BJ Uden.
Postbus 607, 5400 AP Uden (NL).
t 0031 (0)413 - 24 6059.
e info@adezz.com, i www.adezz.com

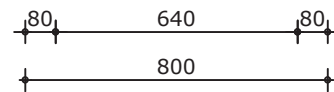
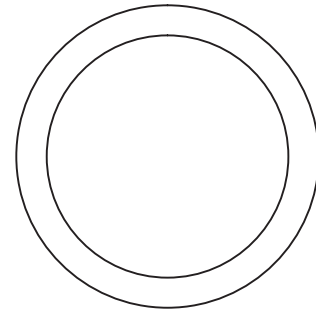

Bovenaanzicht

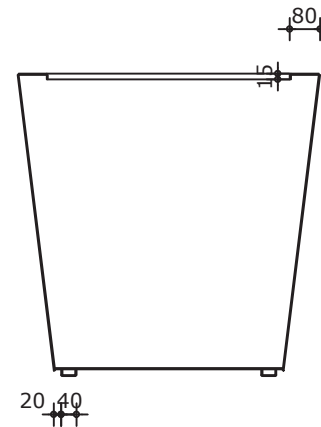

Verticale doorsnede

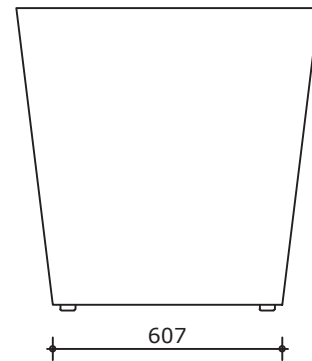

Vooraanzicht



Inhoud : 0.31m3
Gewicht : 23kg
Afwerking : RAL7021

Omschrijving : Cairo AC2
Opdrachtgever : Adezz
Werknummer : Standaard
Plaats : Uden (NL)
Blad : 1/1

Get. : R. Langens
Schaal : 1:20
Datum : 01-04-2014
Wijz. :



Mandenmakerstraat 9, 5405 BJ Uden.
Postbus 607, 5400 AP Uden (NL).
t 0031 (0)413 - 24 6059.
e info@adezz.com, i www.adezz.com

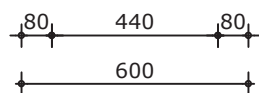
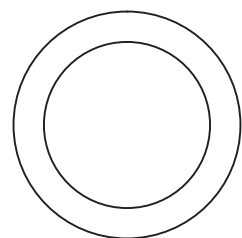

Bovenaanzicht

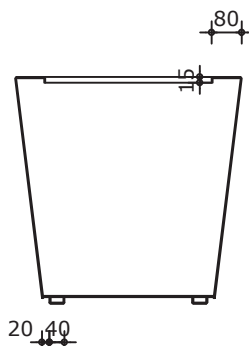

20 40

Verticale doorsnede

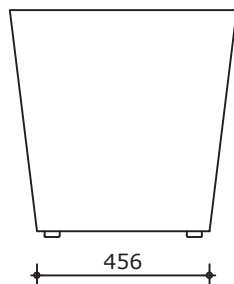

Voorraanzicht



Inhoud : 0.12m3
Gewicht : 13kg
Afwerking : RAL7021

Omschrijving : Cairo AC3
Opdrachtgever : Adezz
Werknnummer : Standaard
Plaats : Uden (NL)
Blad : 1/1

Get. : R. Langens
Schaal : 1:20
Datum : 01-04-2014
Wijz. :



Mandenmakerstraat 9, 5405 BJ Uden.
Postbus 607, 5400 AP Uden (NL).
t 0031 (0)413 - 24 6059.
e info@adezz.com, i www.adezz.com

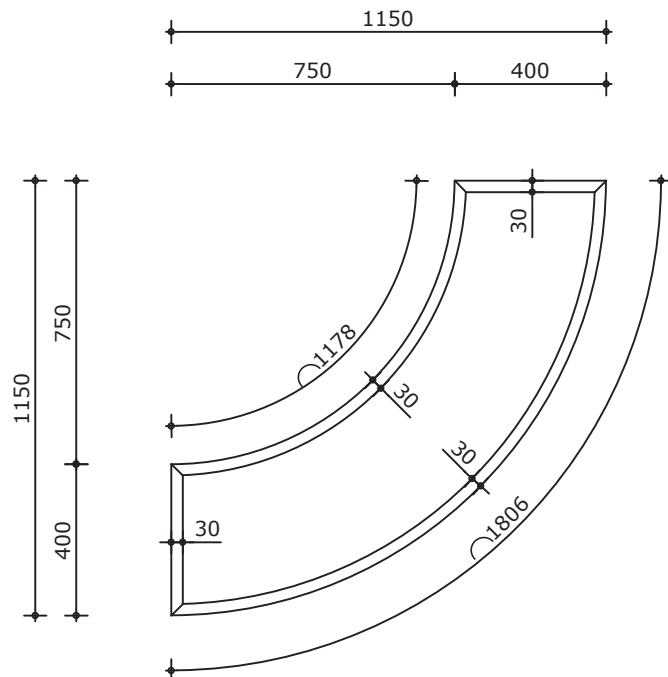

Bovenaanzicht

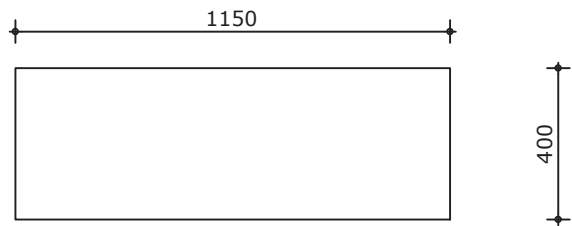

Vooraanzicht

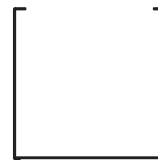

Verticale doorsnede

Inhoud : 0.24m3
 Gewicht : 28kg
 Afwerking : RAL7021

Omschrijving : Alma AR1
 Opdrachtgever : Adezz
 Werknummer : Standaard
 Plaats : Uden (NL)
 Blad : 1/1

Get. : R. Langens
 Schaal : 1:20
 Datum : 01-04-2014
 Wijz. :



Mandenmakerstraat 9, 5405 BJ Uden.
 Postbus 607, 5400 AP Uden (NL).
 t 0031 (0)413 - 24 6059.
 e info@adezz.com, i www.adezz.com

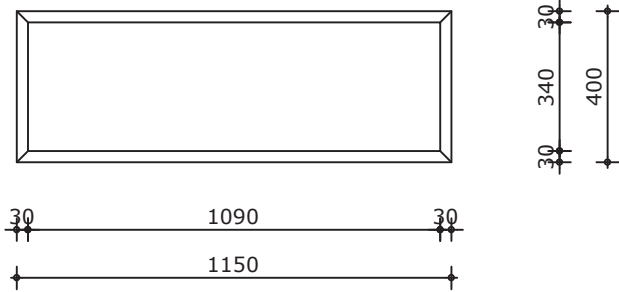

Bovenaanzicht



Vooraanzicht



Verticale doorsnede

Inhoud : 0.18m3
Gewicht : 21kg
Afwerking : RAL7021

<p>Omschrijving : Alma AR2 Opdrachtgever : Adezz Werknummer : Standaard Plaats : Uden (NL) Blad : 1/1</p>	<p>Get. : R. Langens Schaal : 1:20 Datum : 01-04-2014 Wijz. :</p>
---	---



Mandenmakerstraat 9, 5405 BJ Uden.
Postbus 607, 5400 AP Uden (NL).
t 0031 (0)413 - 24 6059.
e info@adezz.com, i www.adezz.com

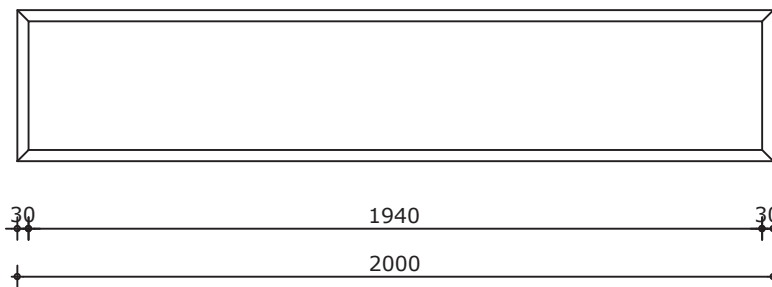

Bovenaanzicht



Vooraanzicht



Verticale doorsnede

Inhoud : 0.32m3
 Gewicht : 34kg
 Afwerking : RAL7021

Omschrijving : Alma AR3
 Opdrachtgever : Adezz
 Werknummer : Standaard
 Plaats : Uden (NL)
 Blad : 1/1

Get. : R. Langens
 Schaal : 1:20
 Datum : 01-04-2014
 Wijz. :



Mandenmakerstraat 9, 5405 BJ Uden.
 Postbus 607, 5400 AP Uden (NL).
 t 0031 (0)413 - 24 6059.
 e info@adezz.com, i www.adezz.com

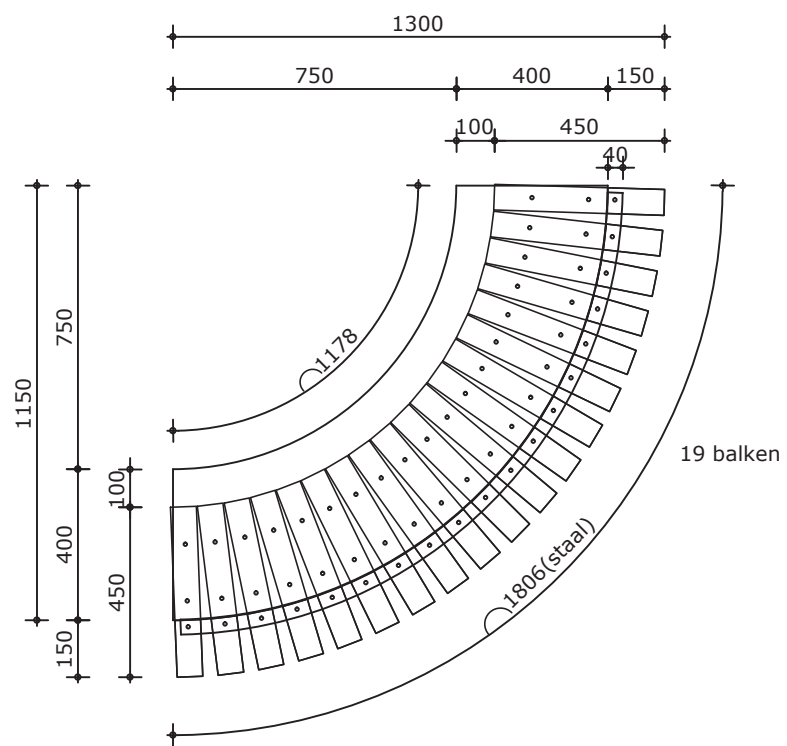

Bovenaanzicht

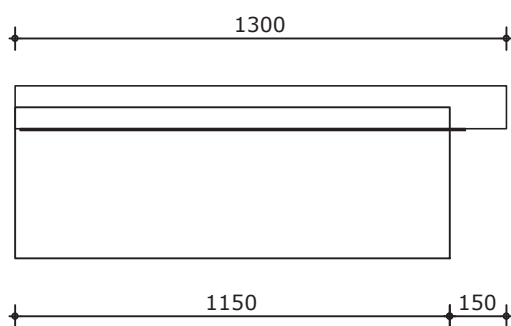

Vooraanzicht

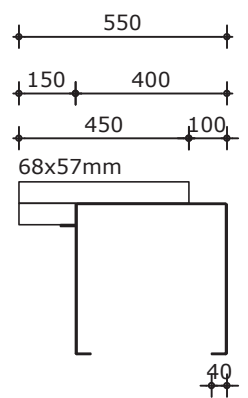

Verticale doorsnede

Gewicht : 100kg
Afwerking : RAL7021

Omschrijving : Alma ARH1
Opdrachtgever : Adezz
Werknummer : Standaard
Plaats : Uden (NL)
Blad : 1/1

Get. : R. Langens
Schaal : 1:20
Datum : 01-04-2014
Wijz. :



Mandenmakerstraat 9, 5405 BJ Uden.
Postbus 607, 5400 AP Uden (NL).
t 0031 (0)413 - 24 6059.
e info@adezz.com, i www.adezz.com

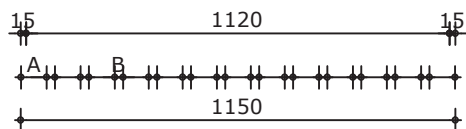
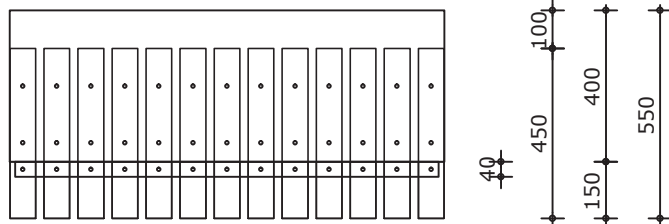

13xA A=68mm
12xB B=12mm

Bovenaanzicht

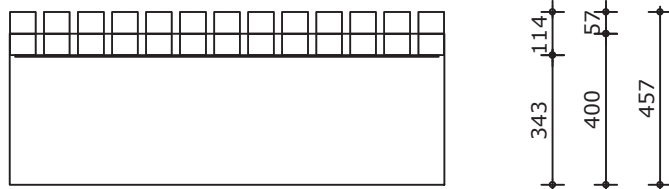

Voorraanzicht

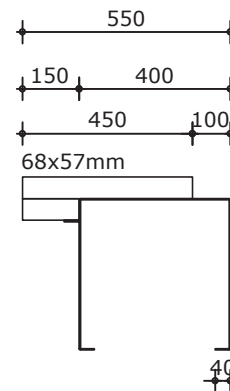

Verticale doorsnede

Gewicht : 69kg
Afwerking : RAL7021

Omschrijving : Alma ARH2
Opdrachtgever : Adezz
Werknummer : Standaard
Plaats : Uden (NL)
Blad : 1/1

Get. : R. Langens
Schaal : 1:20
Datum : 01-04-2014
Wijz. :



Mandenmakerstraat 9, 5405 BJ Uden.
Postbus 607, 5400 AP Uden (NL).
t 0031 (0)413 - 24 6059.
e info@adezz.com, i www.adezz.com

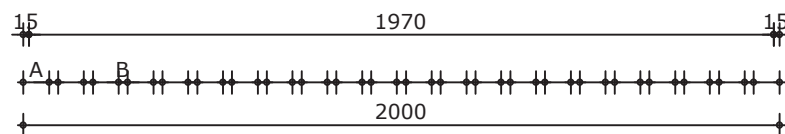
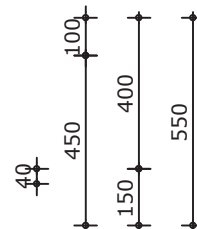
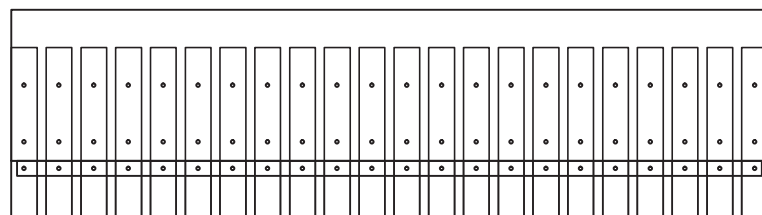

Bovenaanzicht

22xA A=68mm
21xB B=24mm

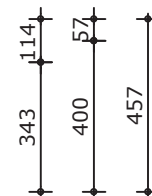
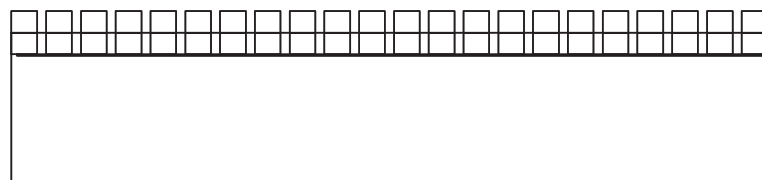

Vooraanzicht

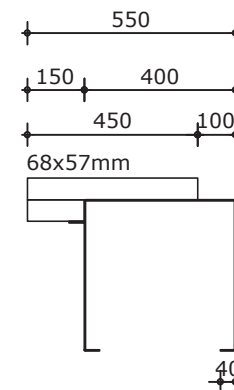

Verticale doorsnede

Gewicht : 120kg
Afwerking : RAL7021

Omschrijving : Alma ARH3
Opdrachtgever : Adezz
Werknummer : Standaard
Plaats : Uden (NL)
Blad : 1/1

Get. : R. Langens
Schaal : 1:20
Datum : 01-04-2014
Wijz. :



Mandenmakerstraat 9, 5405 BJ Uden.
Postbus 607, 5400 AP Uden (NL).
t 0031 (0)413 - 24 6059.
e info@adezz.com, i www.adezz.com

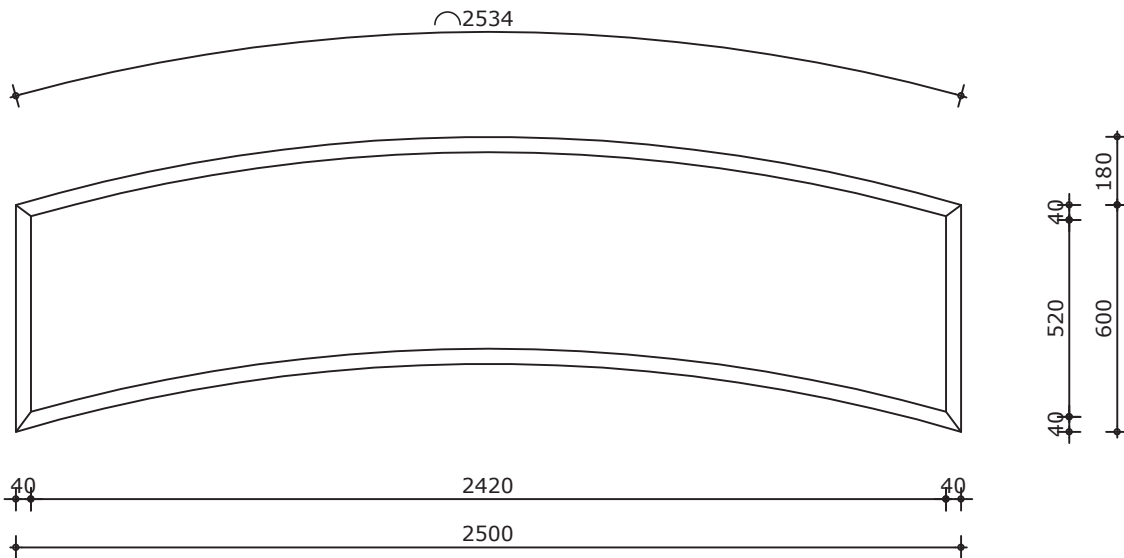

Bovenaanzicht

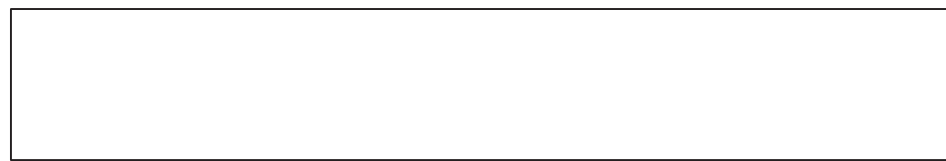

Vooraanzicht

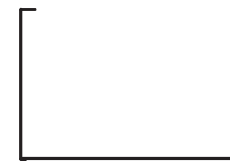

Verticale doorsnede

Inhoud : 0.68m3
Gewicht : 50kg
Afwerking : RAL7021

Omschrijving : Alva AV1
Opdrachtgever : Adezz
Werknummer : Standaard
Plaats : Uden (NL)
Blad : 1/1

Get. : R. Langens
Schaal : 1:20
Datum : 01-04-2014
Wijz. :



Mandenmakerstraat 9, 5405 BJ Uden.
Postbus 607, 5400 AP Uden (NL).
t 0031 (0)413 - 24 6059.
e info@adezz.com, i www.adezz.com

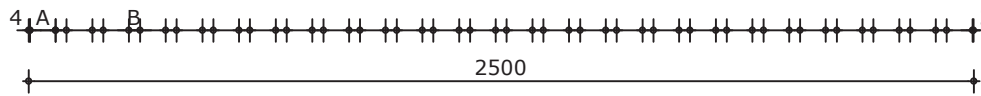
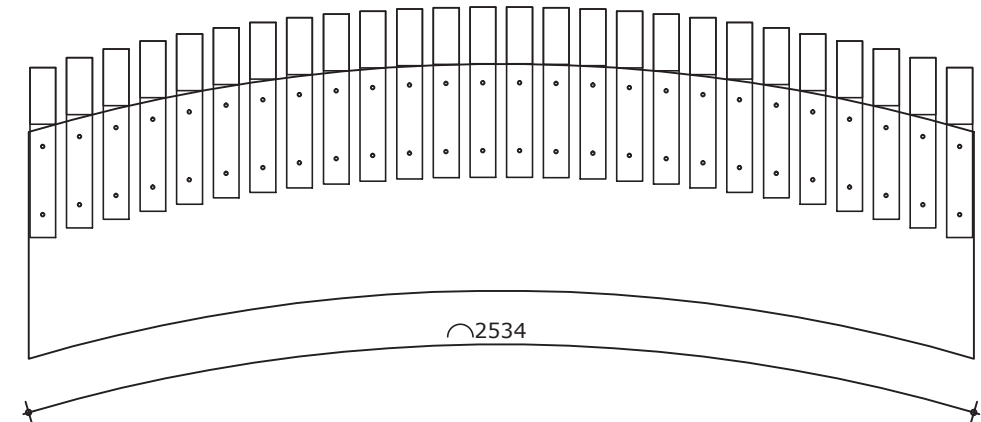

Bovenaanzicht

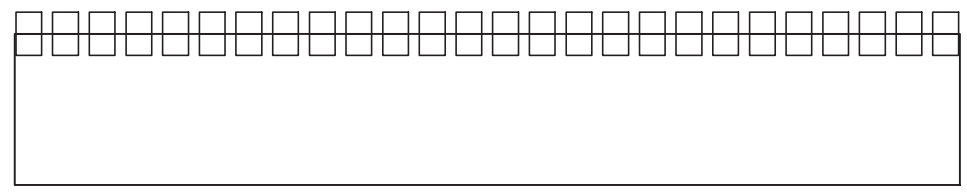

Vooraanzicht



26xA A=68mm
25xB B=29mm

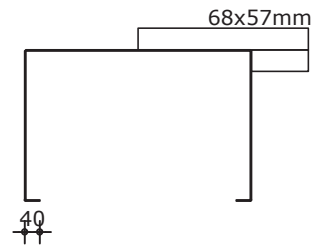
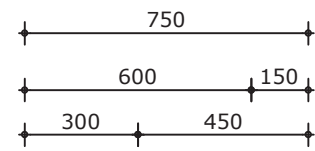

Verticale doorsnede

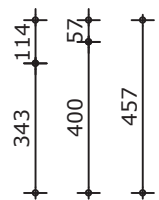

Gewicht : 186kg
Afwerking : RAL7021

Omschrijving : Alva AVH1	Get. : R. Langens
Opdrachtgever : Adezz	Schaal : 1:20
Werknummer : Standaard	Datum : 01-04-2014
Plaats : Uden (NL)	Wijz. :
Blad : 1/1	



Mandenmakerstraat 9, 5405 BJ Uden.
Postbus 607, 5400 AP Uden (NL).
t 0031 (0)413 - 24 6059.
e info@adezz.com, i www.adezz.com