

### Information produit : Bacs en bois exotique

Pour la fabrication de nos bacs, nous n'utilisons que du bois exotique certifié FSC, provenant de sources légales et gérées durablement, d'une durabilité de classe 1. Ceci minimise l'impact sur l'environnement mais aussi procure une impression chaleureuse. Le bois exotique offrant une excellente durabilité, aucun traitement n'est nécessaire. A moins d'appliquer une huile ou un saturateur, le bois va naturellement griser mais cela n'aura aucune incidence sur la qualité des bacs. Ils sont construits avec de la quincaillerie en inox et l'intérieur est recouvert d'un feutre géotextile.

Un traitement à base d'huile peut être appliqué pour une couleur noire ou blanche.

Il est possible de construire certains modèles sur-mesure.

- Avantages :
- Robustesse / durabilité
- Durabilité classe 1
- Aspect naturel / chaleureux
- Design intemporel
- Garantie 5 ans

En option :

- Installation de roulettes (sauf pour la gamme VALENCIA)
- Fabrication sur-mesure
- Format jardinière

Traitement spécial à base d'huile (noire ou blanche)



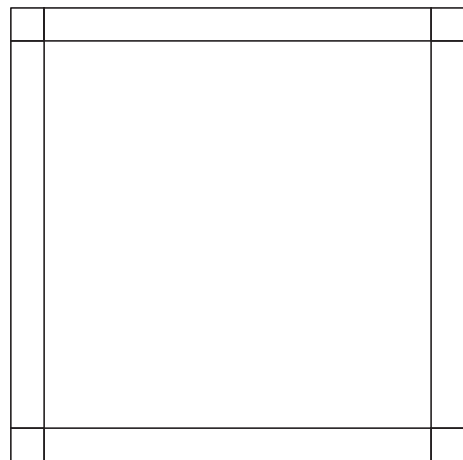

88  
1024  
1200  
88

88 1024 88  
1200

Bovenaanzicht

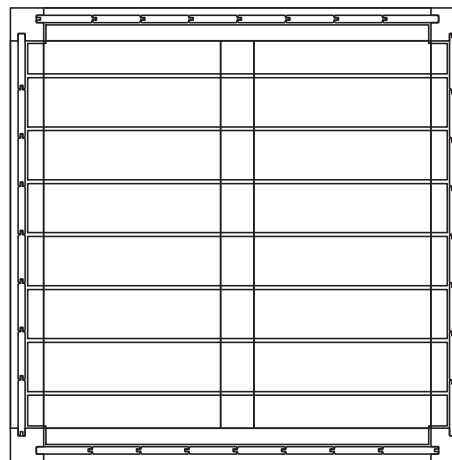

Horizontale doorsnede

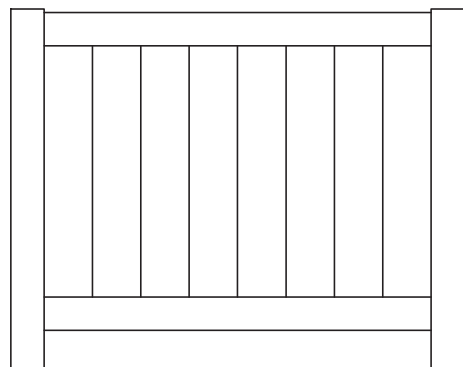

88,10  
664  
950  
100,88

Vooraanzicht

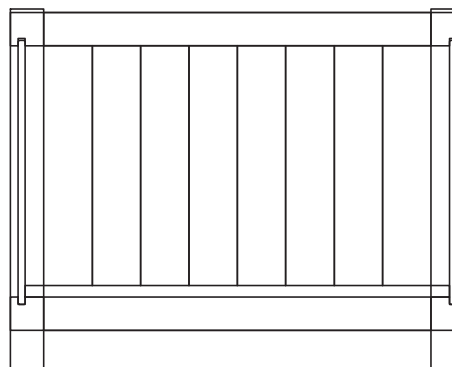

Verticale doorsnede

Inhoud : 0.79m3  
Gewicht : 109kg  
Afwerking : Duurzaamh.kl.A

Omschrijving : Hardhout Valencia HR1  
Opdrachtgever : Adezz  
Werknummer : Standaard  
Plaats : Uden (NL)  
Blad : 1/1

Get. : R. Langens  
Schaal : 1:20  
Datum : 01-04-2014  
Wijz. :



Mandenmakerstraat 9, 5405 BJ Uden.  
Postbus 607, 5400 AP Uden (NL).  
t 0031 (0)413 - 24 6059.  
e info@adezz.com, i www.adezz.com

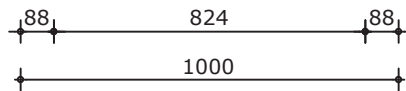
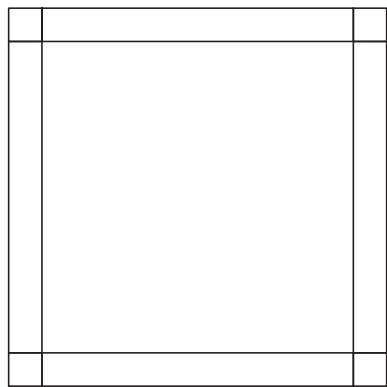

Bovenaanzicht

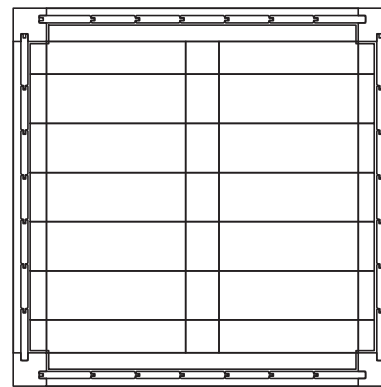

Horizontale doorsnede

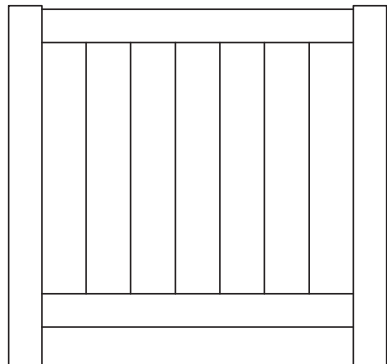

Vooraanzicht

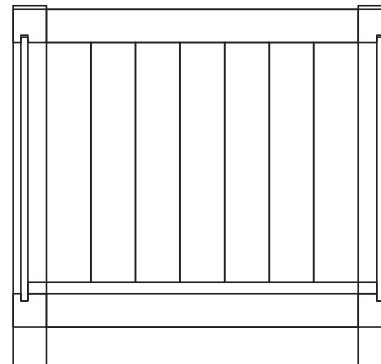

Verticale doorsnede

Inhoud : 0.51m3  
Gewicht : 87kg  
Afwerking : Duurzaamh.kl.A

Omschrijving : Hardhout Valencia HR2  
Opdrachtgever : Adezz  
Werknummer : Standaard  
Plaats : Uden (NL)  
Blad : 1/1

Get. : R. Langens  
Schaal : 1:20  
Datum : 01-04-2014  
Wijz. :



Mandenmakerstraat 9, 5405 BJ Uden.  
Postbus 607, 5400 AP Uden (NL).  
t 0031 (0)413 - 24 6059.  
e info@adezz.com, i www.adezz.com

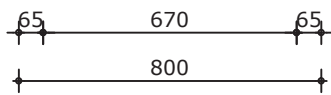
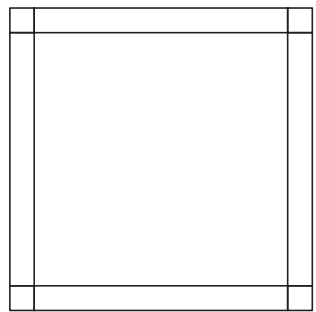

Bovenaanzicht

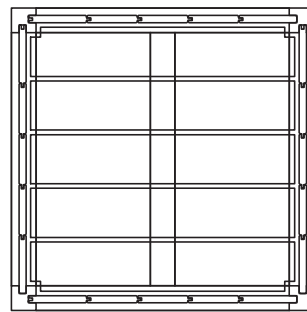

Horizontale doorsnede

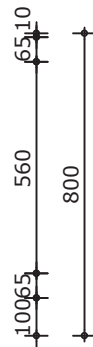
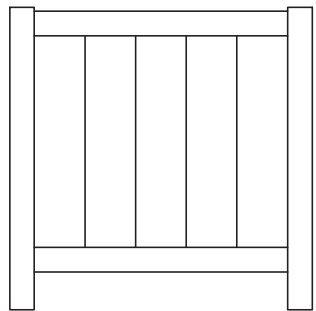

Vooraanzicht

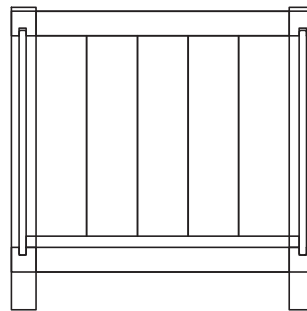

Verticale doorsnede

Inhoud : 0.27m3  
Gewicht : 52kg  
Afwerking : Duurzaamh.kl.A

Omschrijving : Hardhout Valencia HR3  
Opdrachtgever : Adezz  
Werknummer : Standaard  
Plaats : Uden (NL)  
Blad : 1/1

Get. : R. Langens  
Schaal : 1:20  
Datum : 01-04-2014  
Wijz. :



Mandenmakerstraat 9, 5405 BJ Uden.  
Postbus 607, 5400 AP Uden (NL).  
t 0031 (0)413 - 24 6059.  
e info@adezz.com, i www.adezz.com

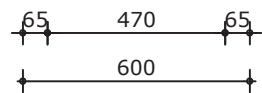
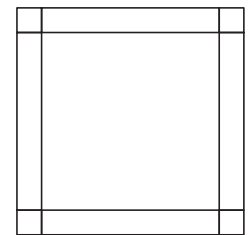

Bovenaanzicht

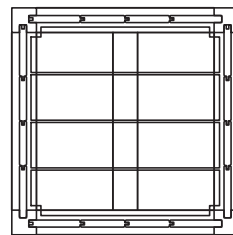

Horizontale doorsnede

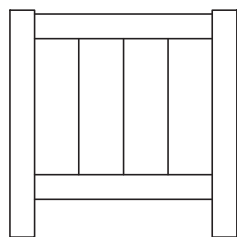

Vooraanzicht

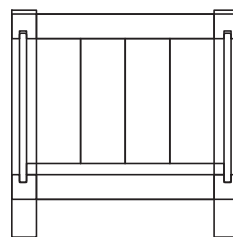

Verticale doorsnede

Inhoud : 0.10m3  
Gewicht : 29kg  
Afwerking : Duurzaamh.kl.A

Omschrijving : Hardhout Valencia HR4  
Opdrachtgever : Adezz  
Werknummer : Standaard  
Plaats : Uden (NL)  
Blad : 1/1

Get. : R. Langens  
Schaal : 1:20  
Datum : 01-04-2014  
Wijz. :



Mandenmakerstraat 9, 5405 BJ Uden.  
Postbus 607, 5400 AP Uden (NL).  
t 0031 (0)413 - 24 6059.  
e info@adezz.com, i www.adezz.com

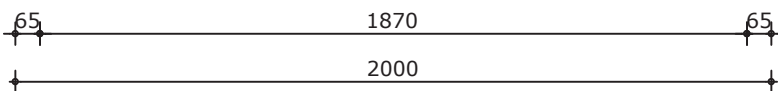
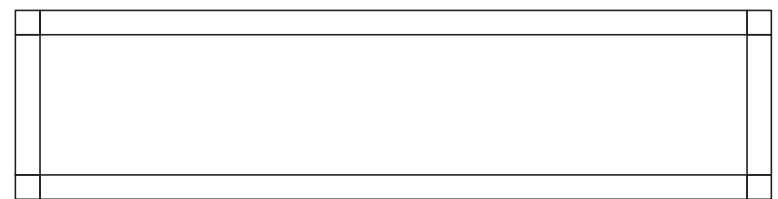

Bovenaanzicht

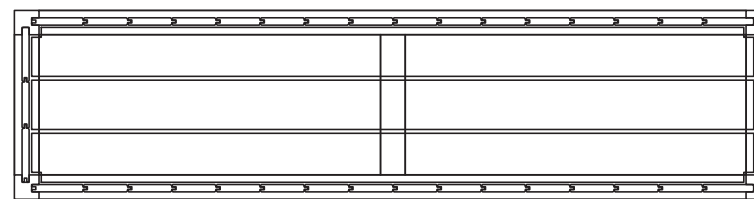

Horizontale doorsnede

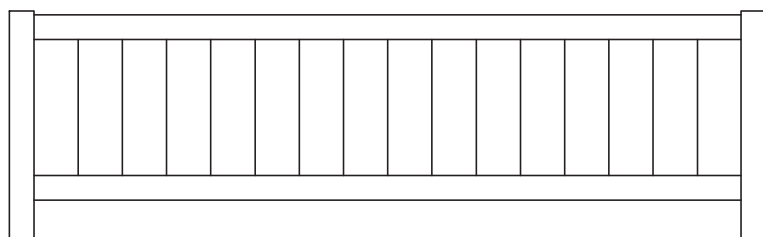

Vooraanzicht

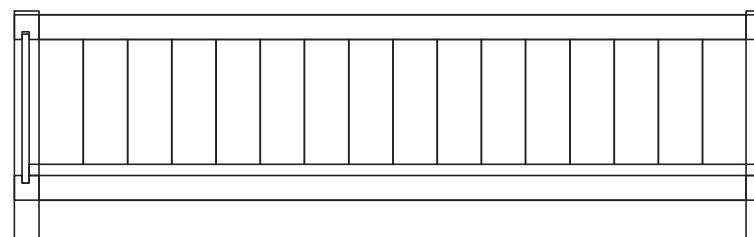

Verticale doorsnede

Inhoud : 0.22m3  
Gewicht : 65kg  
Afwerking : Duurzaamh.kl.A

Omschrijving : Hardhout Valencia HR5  
Opdrachtgever : Adezz  
Werknummer : Standaard  
Plaats : Uden (NL)  
Blad : 1/1

Get. : R. Langens  
Schaal : 1:20  
Datum : 01-04-2014  
Wijz. :



Mandenmakerstraat 9, 5405 BJ Uden.  
Postbus 607, 5400 AP Uden (NL).  
t 0031 (0)413 - 24 6059.  
e info@adezz.com, i www.adezz.com

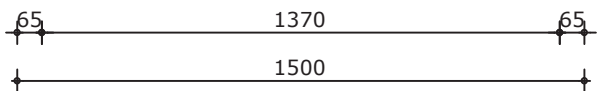
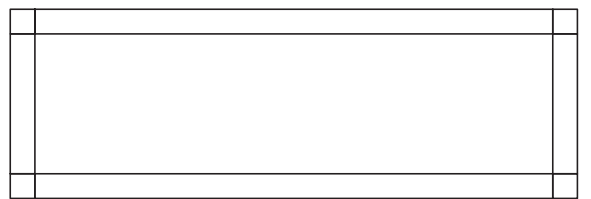

Bovenaanzicht

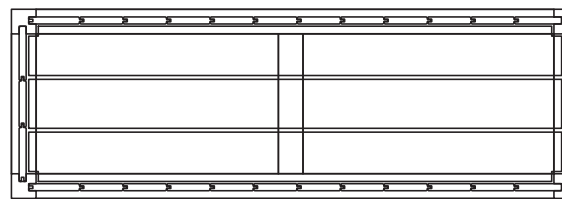

Horizontale doorsnede

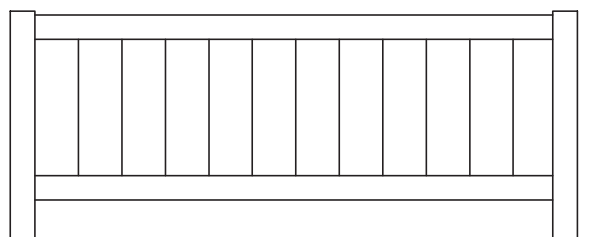

Vooraanzicht

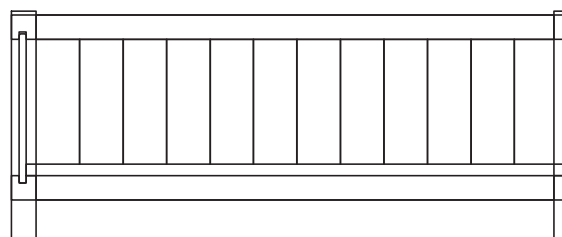

Verticale doorsnede

Inhoud : 0.16m3  
Gewicht : 48kg  
Afwerking : Duurzaamh.kl.A

Omschrijving : Hardhout Valencia HR6  
Opdrachtgever : Adezz  
Werknnummer : Standaard  
Plaats : Uden (NL)  
Blad : 1/1

Get. : R. Langens  
Schaal : 1:20  
Datum : 01-04-2014  
Wijz. :



Mandenmakerstraat 9, 5405 BJ Uden.  
Postbus 607, 5400 AP Uden (NL).  
t 0031 (0)413 - 24 6059.  
e info@adezz.com, i www.adezz.com

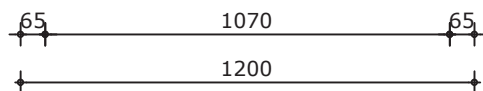
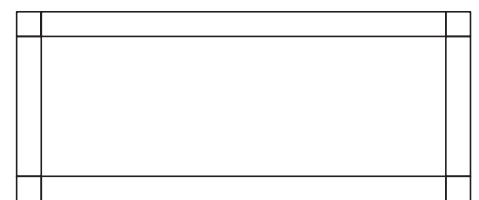

Bovenaanzicht

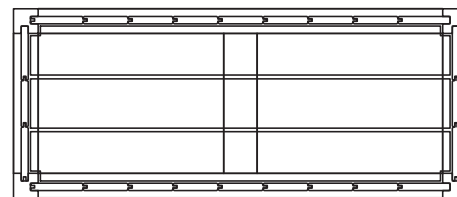

Horizontale doorsnede

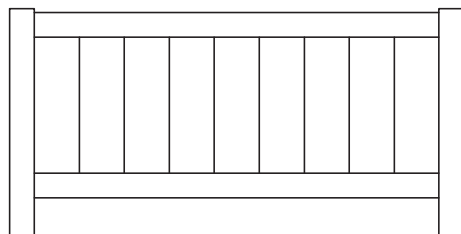

Vooraanzicht

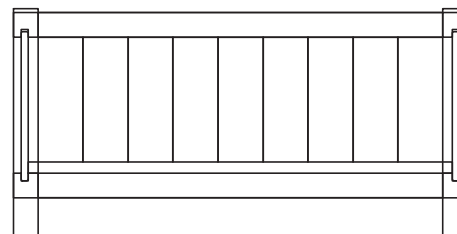

Verticale doorsnede

Inhoud : 0.12m3  
Gewicht : 38kg  
Afwerking : Duurzaamh.kl.A

Omschrijving : Hardhout Valencia HR7  
Opdrachtgever : Adezz  
Werknummer : Standaard  
Plaats : Uden (NL)  
Blad : 1/1

Get. : R. Langens  
Schaal : 1:20  
Datum : 01-04-2014  
Wijz. :



Mandenmakerstraat 9, 5405 BJ Uden.  
Postbus 607, 5400 AP Uden (NL).  
t 0031 (0)413 - 24 6059.  
e info@adezz.com, i www.adezz.com



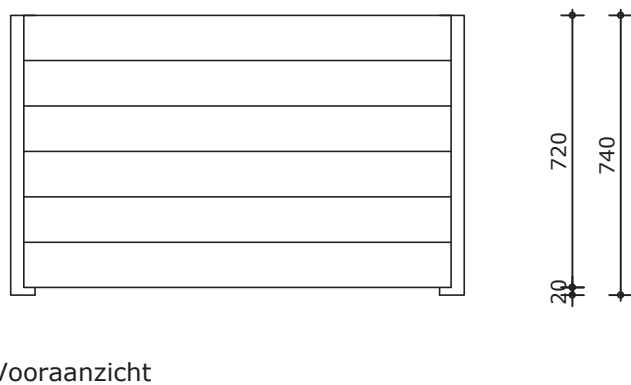
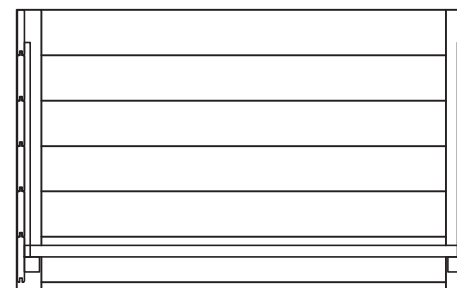
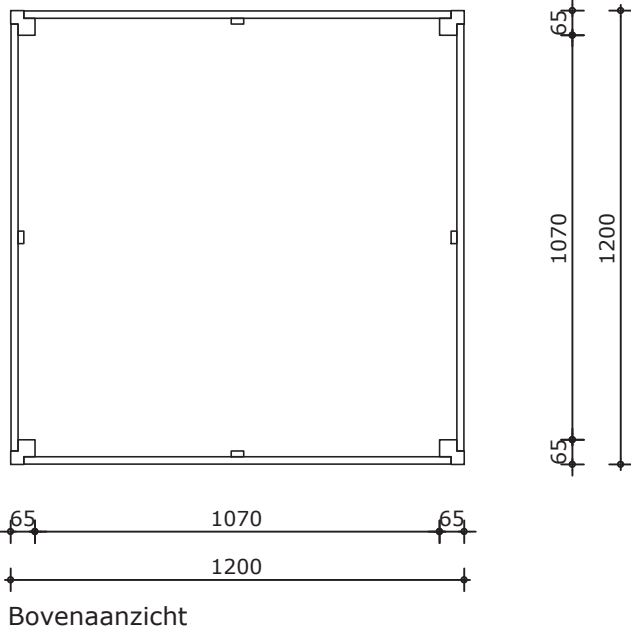

Inhoud : 1.45m3  
 Gewicht : 114kg  
 Afwerking : Duurzaamh.kl.A

Omschrijving : Hardhout Sevilla HS1  
 Opdrachtgever : Adezz  
 Werknummer : Standaard  
 Plaats : Uden (NL)  
 Blad : 1/1

Get. : R. Langens  
 Schaal : 1:20  
 Datum : 01-04-2014  
 Wijz. :



Mandenmakerstraat 9, 5405 BJ Uden.  
 Postbus 607, 5400 AP Uden (NL).  
 t 0031 (0)413 - 24 6059.  
 e info@adezz.com, i www.adezz.com

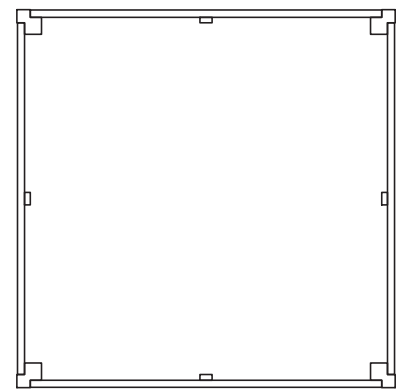

65 870 65  
1000  
Bovenaanzicht

65  
870 1000  
65

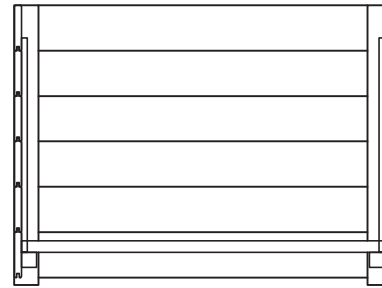

Verticale doorsnede



Vooraanzicht

720  
740  
20

Inhoud : 1.07m3  
Gewicht : 93kg  
Afwerking : Duurzaamh.kl.A

Omschrijving : Hardhout Sevilla HS2  
Opdrachtgever : Adezz  
Werknummer : Standaard  
Plaats : Uden (NL)  
Blad : 1/1

Get. : R. Langens  
Schaal : 1:20  
Datum : 01-04-2014  
Wijz. :



Mandenmakerstraat 9, 5405 BJ Uden.  
Postbus 607, 5400 AP Uden (NL).  
t 0031 (0)413 - 24 6059.  
e [info@adezz.com](mailto:info@adezz.com), i [www.adezz.com](http://www.adezz.com)

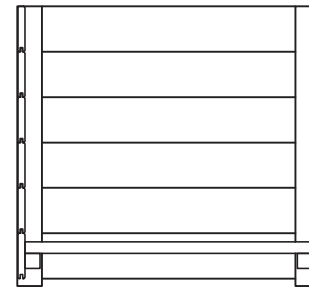
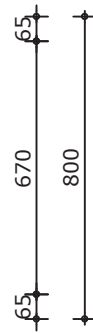
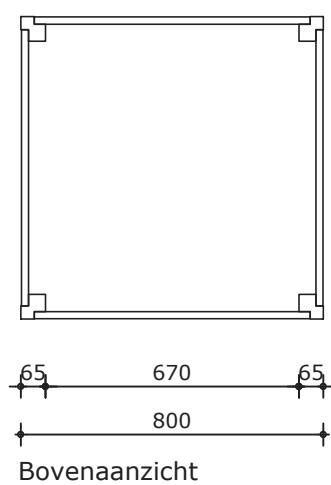

Verticale doorsnede

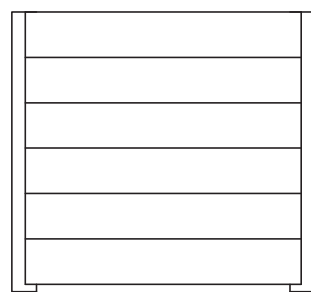

Vooraanzicht

Inhoud : 0.74m3  
 Gewicht : 74kg  
 Afwerking : Duurzaamh.kl.A

Omschrijving : Hardhout Sevilla HS3  
 Opdrachtgever : Adezz  
 Werknummer : Standaard  
 Plaats : Uden (NL)  
 Blad : 1/1

Get. : R. Langens  
 Schaal : 1:20  
 Datum : 01-04-2014  
 Wijz. :



Mandenmakerstraat 9, 5405 BJ Uden.  
 Postbus 607, 5400 AP Uden (NL).  
 t 0031 (0)413 - 24 6059.  
 e info@adezz.com, i www.adezz.com

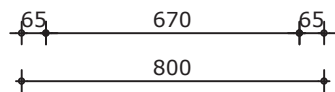
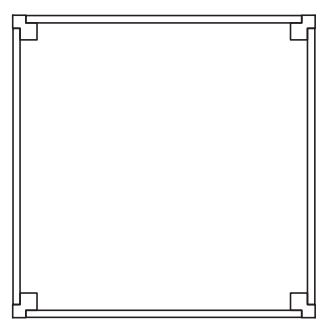

Bovenaanzicht

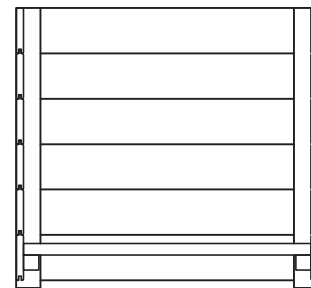
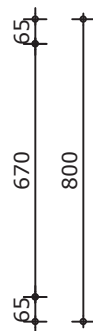

Verticale doorsnede

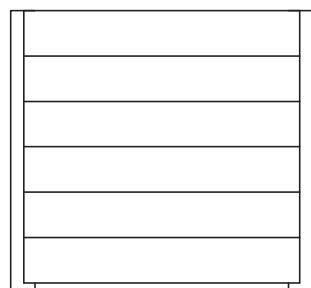

Vooraanzicht



Inhoud : 0.47m3  
Gewicht : 56kg  
Afwerking : Duurzaamh.kl.A

Omschrijving : Hardhout Sevilla HS4  
Opdrachtgever : Adezz  
Werknummer : Standaard  
Plaats : Uden (NL)  
Blad : 1/1

Get. : R. Langens  
Schaal : 1:20  
Datum : 01-04-2014  
Wijz. :



Mandenmakerstraat 9, 5405 BJ Uden.  
Postbus 607, 5400 AP Uden (NL).  
t 0031 (0)413 - 24 6059.  
e info@adezz.com, i www.adezz.com

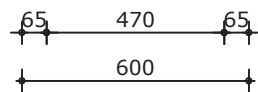
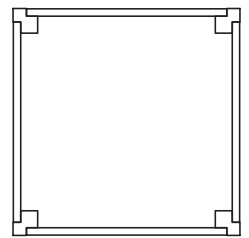

Bovenaanzicht

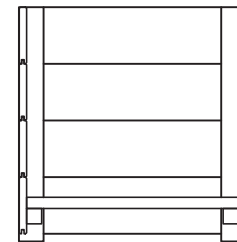
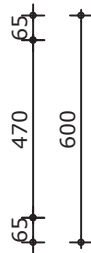

Verticale doorsnede

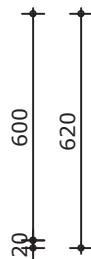
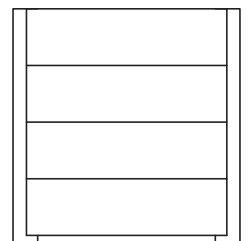

Vooraanzicht

Inhoud : 0.22m3  
Gewicht : 34kg  
Afwerking : Duurzaamh.kl.A

Omschrijving : Hardhout Sevilla HS5  
Opdrachtgever : Adezz  
Werknummer : Standaard  
Plaats : Uden (NL)  
Blad : 1/1

Get. : R. Langens  
Schaal : 1:20  
Datum : 01-04-2014  
Wijz. :



Mandenmakerstraat 9, 5405 BJ Uden.  
Postbus 607, 5400 AP Uden (NL).  
t 0031 (0)413 - 24 6059.  
e [info@adezz.com](mailto:info@adezz.com), i [www.adezz.com](http://www.adezz.com)

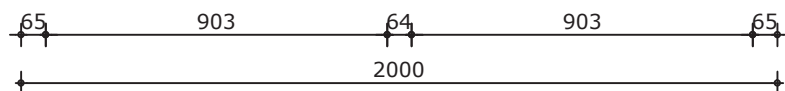
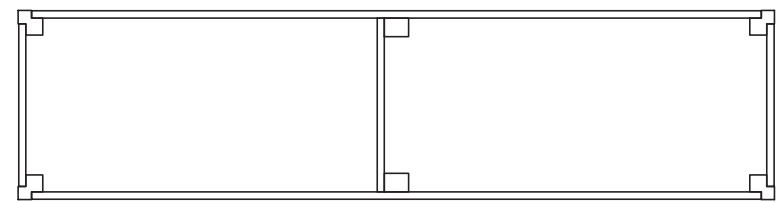

Bovenaanzicht

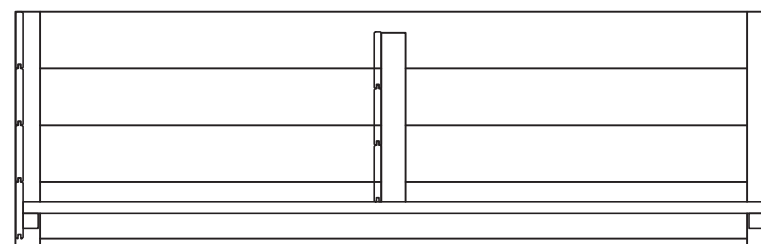

Verticale doorsnede

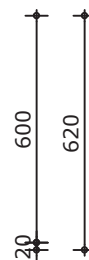

Vooraanzicht

Inhoud : 0.62m3  
Gewicht : 75kg  
Afwerking : Duurzaamh.kl.A

Omschrijving : Hardhout Sevilla HS6  
Opdrachtgever : Adezz  
Werknummer : Standaard  
Plaats : Uden (NL)  
Blad : 1/1

Get. : R. Langens  
Schaal : 1:20  
Datum : 01-04-2014  
Wijz. :



Mandenmakerstraat 9, 5405 BJ Uden.  
Postbus 607, 5400 AP Uden (NL).  
t 0031 (0)413 - 24 6059.  
e [info@adezz.com](mailto:info@adezz.com), i [www.adezz.com](http://www.adezz.com)

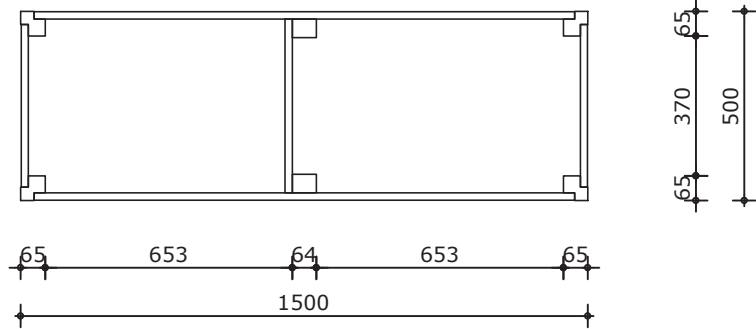

Bovenaanzicht

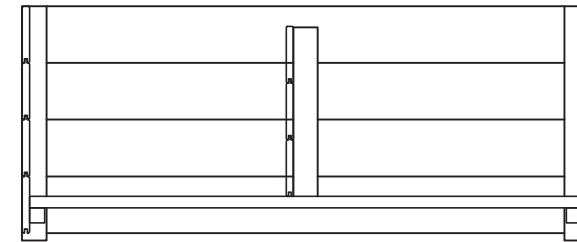

Verticale doorsnede

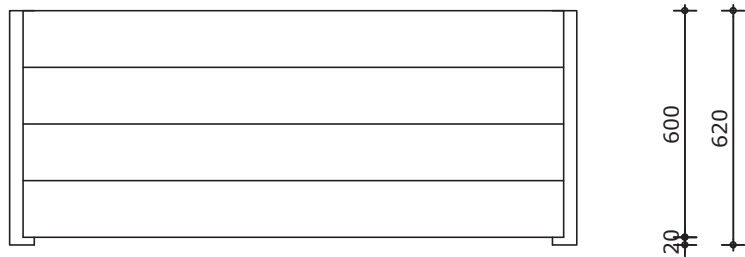

Vooraanzicht

Inhoud : 0.47m3  
 Gewicht : 59kg  
 Afwerking : Duurzaamh.kl.A

Omschrijving : Hardhout Sevilla HS7  
 Opdrachtgever : Adezz  
 Werknummer : Standaard  
 Plaats : Uden (NL)  
 Blad : 1/1

Get. : R. Langens  
 Schaal : 1:20  
 Datum : 01-04-2014  
 Wijz. :



Mandenmakerstraat 9, 5405 BJ Uden.  
 Postbus 607, 5400 AP Uden (NL).  
 t 0031 (0)413 - 24 6059.  
 e info@adezz.com, i www.adezz.com

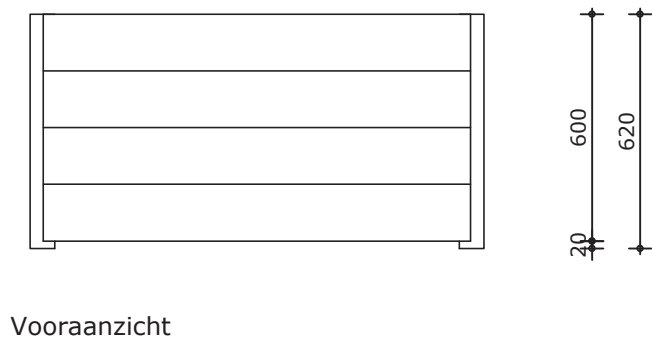
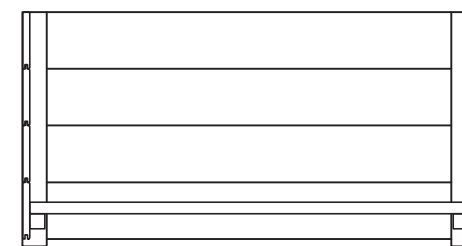
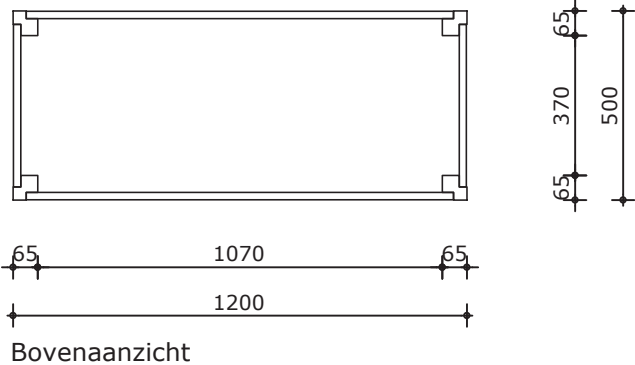

Inhoud : 0.37m3  
 Gewicht : 49kg  
 Afwerking : Duurzaamh.kl.A

Omschrijving : Hardhout Sevilla HS8	Get. : R. Langens
Opdrachtgever : Adezz	Schaal : 1:20
Werknummer : Standaard	Datum : 01-04-2014
Plaats : Uden (NL)	Wijz. :
Blad : 1/1	



Mandenmakerstraat 9, 5405 BJ Uden.  
 Postbus 607, 5400 AP Uden (NL).  
 t 0031 (0)413 - 24 6059.  
 e info@adezz.com, i www.adezz.com



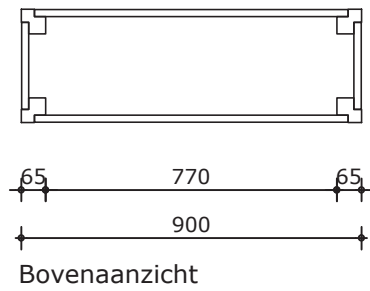

Verticale doorsnede

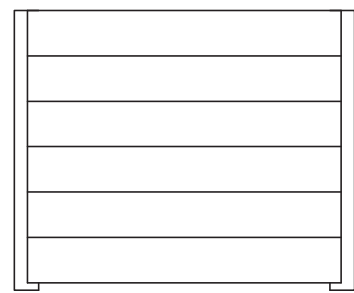

Vooraanzicht



Inhoud : 0.20m3  
 Gewicht : 38kg  
 Afwerking : Duurzaamh.kl.A

Omschrijving : Hardhout Sevilla HS9  
 Opdrachtgever : Adezz  
 Werknummer : Standaard  
 Plaats : Uden (NL)  
 Blad : 1/1

Get. : R. Langens  
 Schaal : 1:20  
 Datum : 01-04-2014  
 Wijz. :



Mandenmakerstraat 9, 5405 BJ Uden.  
 Postbus 607, 5400 AP Uden (NL).  
 t 0031 (0)413 - 24 6059.  
 e info@adezz.com, i www.adezz.com

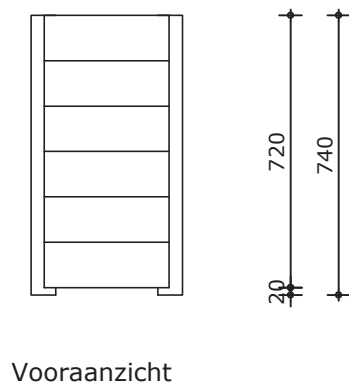
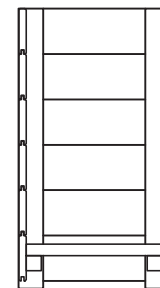
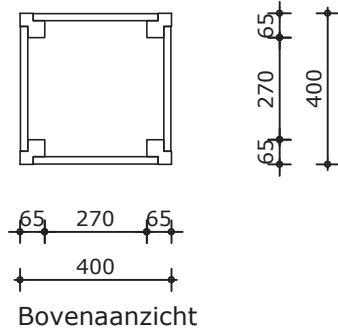

Inhoud : 0.12m3  
Gewicht : 25kg  
Afwerking : Duurzaamh.kl.A

Omschrijving : Hardhout Sevilla HS10  
Opdrachtgever : Adezz  
Werknummer : Standaard  
Plaats : Uden (NL)  
Blad : 1/1

Get. : R. Langens  
Schaal : 1:20  
Datum : 01-04-2014  
Wijz. :



Mandenmakerstraat 9, 5405 BJ Uden.  
Postbus 607, 5400 AP Uden (NL).  
t 0031 (0)413 - 24 6059.  
e info@adezz.com, i www.adezz.com

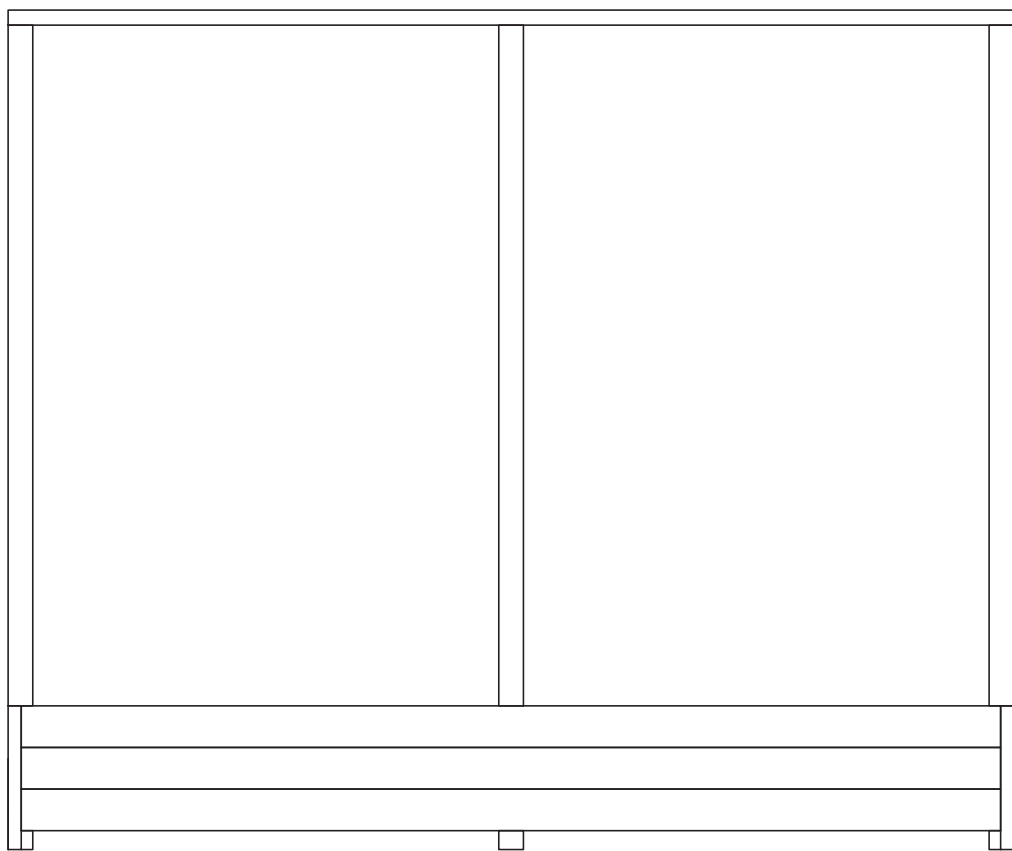

Vooraanzicht

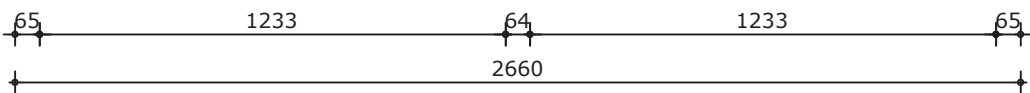
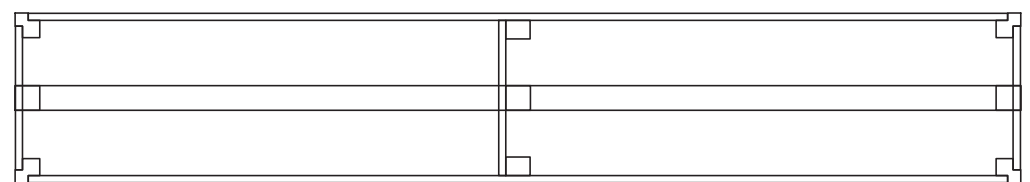

Bovenaanzicht

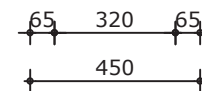
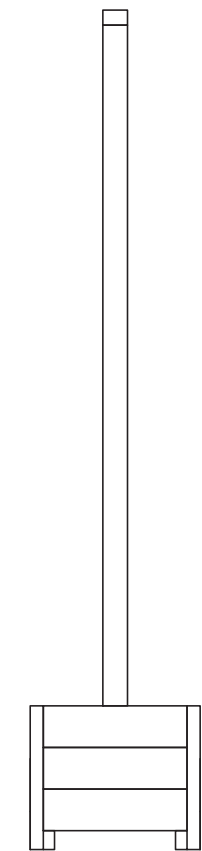
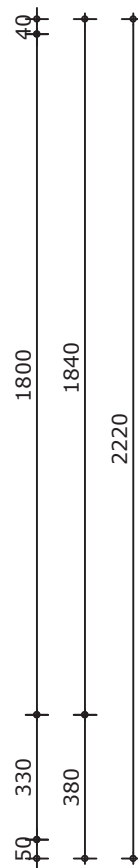

Zijaanzicht

Inhoud : 0.45m3  
 Gewicht : 112kg  
 Afwerking : Duurzaamh.kl.A

Omschrijving : Hardhout Haagbak HH1  
 Opdrachtgever : Adezz  
 Werknummer : Standaard  
 Plaats : Uden (NL)  
 Blad : 1/1

Get. : R. Langens  
 Schaal : 1:20  
 Datum : 01-04-2014  
 Wijz. :



Mandenmakerstraat 9, 5405 BJ Uden.  
 Postbus 607, 5400 AP Uden (NL).  
 t 0031 (0)413 - 24 6059.  
 e info@adezz.com, i www.adezz.com

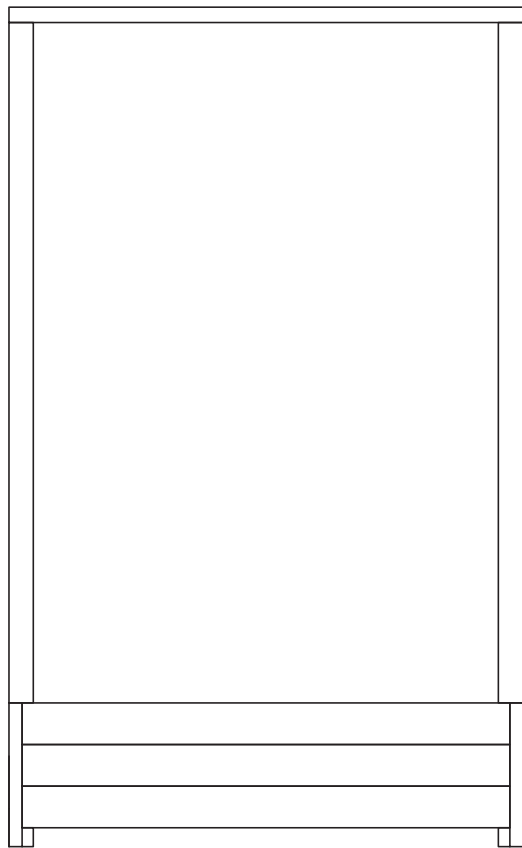

Vooraanzicht

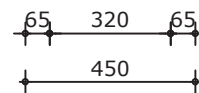
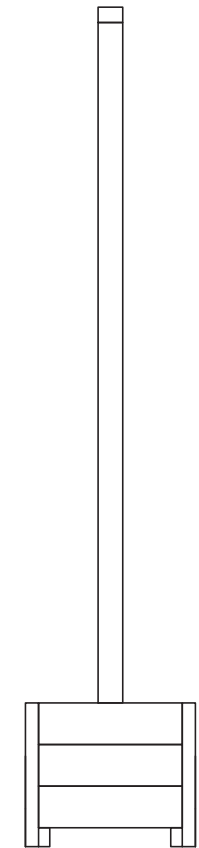
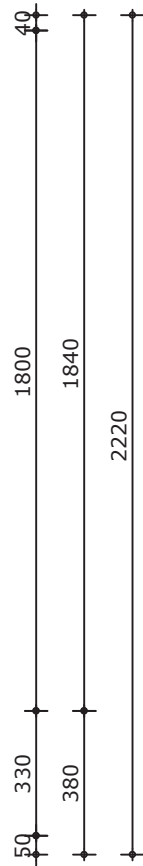

Zijaanzicht

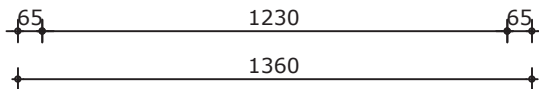
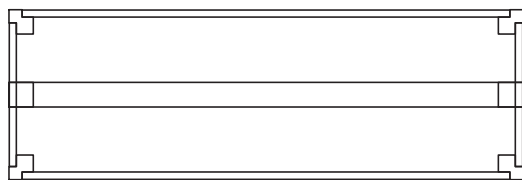

Bovenaanzicht

Inhoud : 0.23m3  
 Gewicht : 68kg  
 Afwerking : Duurzaamh.kl.A

Omschrijving : Hardhout Haagbak HH2  
 Opdrachtgever : Adezz  
 Werknummer : Standaard  
 Plaats : Uden (NL)  
 Blad : 1/1

Get. : R. Langens  
 Schaal : 1:20  
 Datum : 01-04-2014  
 Wijz. :



Mandenmakerstraat 9, 5405 BJ Uden.  
 Postbus 607, 5400 AP Uden (NL).  
 t 0031 (0)413 - 24 6059.  
 e info@adezz.com, i www.adezz.com